

Thermo Scientific
Heratherm
Advanced Protocol and
Advanced Protocol Security
Heating and Drying Ovens

OGH 60/100/180
OGH 60-S/100-S/180-S
OMH 60/100/180/400/750
OMH 60-S/100-S/180-S

Operating Instructions

50125557 B

14.06.12



© 2012 Thermo Fisher Scientific Inc. All rights reserved.

These operating instructions are protected by copyright. Rights resulting thereof, particularly reprint, photomechanical or digital postprocessing or reproduction, even in part, are only allowed with the written consent of Thermo Fisher Scientific.

This regulation does not apply to reproductions for in-plant use.

The contents of this operating instructions manual may change at any time and without any prior notice. In case of conflicting translations into foreign languages the German-language version of these operating instructions shall be binding.

Trademarks

Heratherm[®] is a registered trademark of Thermo Scientific.

Thermo Scientific is a brand owned by Thermo Fisher Scientific Inc.

All other trademarks mentioned in the operating instructions are the exclusive property of the respective manufacturers.

Thermo Electron LED GmbH
Robert-Bosch-Straße 1
D - 63505 Langenselbold
Germany

Thermo Electron LED GmbH is an affiliate to:
Thermo Fisher Scientific Inc.
81 Wyman Street
Waltham, MA 02454
USA

Thermo Fisher Scientific Inc. provides this document to its customers with a product purchase to use in the product operation. This document is copyright protected and any reproduction of the whole or any part of this document is strictly prohibited, except with the written authorization of Thermo Fisher Scientific Inc.

The contents of this document are subject to change without notice.

All technical information in this document is for reference purposes only. System configurations and specifications in this document supersede all previous information received by the purchaser.

Thermo Fisher Scientific Inc. makes no representations that this document is complete, accurate or error-free and assumes no responsibility and will not be liable for any errors, omissions, damage or loss that might result from any use of this document, even if the information in the document is followed properly.

This document is not part of any sales contract between Thermo Fisher Scientific Inc. and a purchaser. This document shall in no way govern or modify any Terms and Conditions of Sale, which Terms and Conditions of Sale shall govern all conflicting information between the two documents.

Contents

Chapter 1	Safety Notes	1-1
	Basic Operating Precautions	1-1
	Operational Safety Rules	1-2
	Warranty	1-2
	Explanation of Safety Information and Symbols	1-3
	Safety Notes and Symbols Used Throughout These Operating Instructions	1-3
	Additional Symbols for Safety Information	1-4
	Symbols on the Oven	1-5
	Intended Purpose of the Oven	1-5
	Correct use	1-5
	Incorrect Use	1-5
	Standards and Directives	1-6
Chapter 2	Delivery of the Oven	2-1
	Packaging	2-1
	Acceptance Inspection	2-1
	Scope of Supply	2-2
Chapter 3	Installation	3-1
	Ambient Conditions	3-1
	Location Requirements	3-1
	Use with Air Exhaust Systems	3-1
	Intermediate Storage	3-3
	Room Ventilation	3-3
	Use with Air Exhaust Systems	3-3
	Space Requirement	3-4
	Installation Built-in Units	3-4
	Table-top units	3-5
	Floor stand units	3-6
	Transport	3-8
	Table-top units	3-8
	Stacking Kit	3-10
	Installing the Stacking Feet	3-10
	Installing the Stacking Adapter	3-11
	Installing the Anti-tilt Anchor	3-12
	Table-top units	3-12
	Floor stand units	3-13
	Floor stand unit spacers	3-14
Chapter 4	Product Description	4-1
	Heratherm OGH Series Oven Overview	4-1

Heratherm OGH-S Series Oven Overview	4-3
Heratherm OMH Series Oven Overview.....	4-5
Heratherm OMH-S Series Oven Overview	4-12
Safety Devices.....	4-15
Operating Environment	4-15
Door switch.....	4-15
Sensing and Control System	4-16
Data Communications & Alarm Interface.....	4-17
RS 232 interface	4-17
Alarm contact	4-18
AC Power Socket.....	4-18
Fuses.....	4-18
Work Space Components	4-18
Inner Chamber	4-18
Product Options of Table-top units.....	4-20
Door Fitted with Viewing Windows and Workspace Lighting	4-20
Tube Access Ports of Table-top units.....	4-21
Chapter 5 Start-up	5-1
Table-top units.....	5-1
Installing the Shelf System	5-1
Initial installation	5-1
Installing the Shelving	5-2
Preparing the Work Space	5-3
Table-top units	5-3
Installation or Removal of the Support Rails (OMH Series and OMH-S Series only).....	5-3
Installing and Uninstalling the Rear Air Baffle (OMH Series and OMH-S Series only).....	5-4
Installing and Uninstalling the Lateral Air Baffles (OGH Series and OGH-S Series only)	5-5
Levelling the Oven	5-6
Commissioning of floor-mounted units.....	5-7
Installing/Removing air baffles (OMH Series)	5-7
Commissioning, general	5-8
Installing the Shelf Support Brackets	5-8
Installing the Wire-mesh Shelves	5-9
Connecting Power	5-9
Connection to the Power Supply Source.....	5-10
Connecting the RS-232 Interface	5-11
Interconnecting the Oven with a Computer	5-11
Wiring the Alarm Contact	5-13
Functional Description	5-13
Alarm Relay Specifications.....	5-14
Connection Example	5-14
Chapter 6 Operation.....	6-1
Preparing the Oven	6-1
Starting Operation.....	6-1
Chapter 7 Handling and Control	7-1
Powering Up	7-6

Switching the Oven Off / Powering Down.....	7-6
Temperature Set Value.....	7-7
Timer.....	7-9
Setting a Fixed-time On or Off Timer.....	7-11
Setting a Weekly Timer.....	7-12
Stopping a Timer.....	7-14
Light.....	7-16
Boost.....	7-18
Fan.....	7-20
Table-top units.....	7-20
Floor mounted units.....	7-22
Damper.....	7-24
Settings.....	7-26
Error Log.....	7-26
Calibration.....	7-27
Date and Time.....	7-31
Temperature Display Unit.....	7-34
Process Protection.....	7-35
Program Preferences.....	7-36
Configuration.....	7-38
Programming.....	7-40
End of Program.....	7-40
ECO Convenience Program (only for table-top units).....	7-40
Instructions.....	7-42
Chapter 8 Shut-down.....	8-1
Shutting the Oven Down.....	8-1
Chapter 9 Cleaning and Disinfection.....	9-1
Cleaning.....	9-1
Cleaning Exterior Surfaces.....	9-1
Wipe / Spray Disinfection.....	9-1
Preparing the manual wipe/spray disinfection.....	9-2
Predisinfection.....	9-3
Chapter 10 Maintenance.....	10-1
Inspections and checks.....	10-1
Service Intervals.....	10-2
Preparing Temperature Calibration.....	10-2
Comparison Measurement Procedure.....	10-3
Temperature Calibration Procedure.....	10-3
Replacing the Door Seal.....	10-3
Replacing the Power Cord.....	10-4
Returns for Repair.....	10-4
Chapter 11 Disposal.....	11-1
Overview of Materials Used.....	11-1

Contents

Chapter 12 Error Codes 12-1

Chapter 13 Technical Data 13-1

Chapter 14 Spare Parts and Accessories 14-1

Chapter 15 Device Log..... 15-1

Chapter 16 Contact 16-1

List of Figures

Figure 3-1 Table-top oven units, dimensions and required clearances	3-5
Figure 3-2 Floor stand ovens, dimensions and required clearances	3-6
Figure 3-3 Floor stand ovens, dimensions and required clearances	3-7
Figure 3-4 Lift Points.....	3-8
Figure 4-1 Heratherm OGH 60/ OGH 100/ OGH 180 Series Front View.....	4-2
Figure 4-2 Heratherm OGH 60/ OGH 100/ OGH 180 Series Rear View	4-3
Figure 4-3 Heratherm OGH-S Front View.....	4-4
Figure 4-4 Heratherm OGH-S Rear View	4-5
Figure 4-5 Heratherm OMH 60/ OMH 100/ OMH 180 Series Front View.....	4-6
Figure 4-6 Heratherm OMH 60/ OMH 100/ OMH 180 Series Rear View	4-7
Figure 4-7 Heratherm OMH 400 Series Front View	4-8
Figure 4-8 Heratherm OMH 400 Series Rear View	4-9
Figure 4-9 Heratherm OMH 750 Series Front View	4-10
Figure 4-10 Heratherm OMH 750 Series Rear View	4-11
Figure 4-11 Heratherm OMH-S Front View.....	4-13
Figure 4-12 Heratherm OMH-S Rear View.....	4-14
Figure 4-13 Sensor Mounting Location - OGH Series - Table-top units	4-16
Figure 4-14 Sensor Mounting Location - OMH Series - Table-top units.....	4-16
Figure 4-15 Sensor Mounting Location - OMH Series - Floor stand units	4-16
Figure 4-16 Signal Interfaces and Power Socket	4-17
Figure 4-17 Shelf System - OGH Series and OGH-S Series Oven	4-19
Figure 4-18 Shelf System - OMH Series and OMH-S Series Oven.....	4-20
Figure 4-19 Viewing Package Front View	4-21
Figure 4-20 Tube Access Ports.....	4-22
Figure 5-1 Sliding the Retaining Spring into the Support Rail.....	5-1
Figure 5-2 OGH and OGH-S Series - Installing the Shelving.....	5-2
Figure 5-3 OMH and OMH-S Series - Installing the Shelving	5-2
Figure 5-4 Support Rail Installation.....	5-3
Figure 5-5 Installing the Rear Air Baffle.....	5-4
Figure 5-6 Removing the Bottom Panel.....	5-5
Figure 5-7 Bottom Panel Removed.....	5-5
Figure 5-8 Removing the Lateral Air Baffle.....	5-6
Figure 5-9 Removing the left and right support profiles.....	5-7
Figure 5-10 Removing the rear air baffle OMH 400/750	5-7
Figure 5-11 Shelf Support Bracket Installation	5-8

List of Figures

Figure 5-12 Wire-mesh shelf.....	5-9
Figure 5-13 AC Power Supply Socket.....	5-11
Figure 7-1 Control Panel for Heratherm OGH Series, OMH Series, OGH-S Series and OMH-S Series Ovens....	7-1
Figure 10-1 Door seal replacement (example showing OMH Series oven)	10-4

Safety Notes

Basic Operating Precautions

These operating instructions describe Heratherm ovens.

Heratherm ovens have been manufactured to the latest state of the art and been tested thoroughly for flawless functioning prior to shipping. However, the oven may present potential hazards, particularly if it is operated by inadequately trained personnel or if it is not used in accordance with the intended purpose. Therefore, the following must be observed for the sake of accident prevention:

- Heratherm ovens must be operated by adequately trained and authorized professional personnel.
- Heratherm ovens must not be operated unless these operating instructions have been fully read and understood.
- The present operating instructions, applicable safety data sheets, plant hygiene guidelines and the corresponding technical rules issued by the operator shall be used to create written procedures targeted at personnel working with the subject matter device, detailing:
 - the safety precautions to be taken when processing specific agents,
 - the measures to be taken in case of accidents.
- Repair work on the oven must be carried out only by trained and authorized expert personnel.
- The contents of these operating instructions are subject to change at any time without further notice.
- Concerning translations into foreign languages, the German version of these operating instructions is binding.
- Keep these operating instructions close to the oven so that safety instructions and important information are always accessible.
- Should you encounter problems that are not detailed adequately in these operating instructions, please contact Thermo Electron LED GmbH immediately for your own safety.

Operational Safety Rules

The following rules must be heeded when working with Heratherm ovens:

- Observe the sample weight limits specified for your Heratherm oven as a whole and its shelving in particular; see “[Technical Data](#)” on [page 13-1](#)).
- Do not load the bottom of the interior workspace to avoid the risk of overheating any samples placed there.
- Arrange the samples evenly throughout the work space, making sure not to place them too closely to the interior walls to ensure a uniform temperature distribution.
- Do not load your Heratherm oven with substances that exceed the capabilities of the available lab apparatus and Personal Protection Equipment to provide sufficient degrees of protection to users and third parties.
- Check the door seal once a week for proper sealing performance and possible damage.
- Do not process any samples containing hazardous chemical substances that may be released into the ambient air through defective seals or may cause corrosion or other defects on parts of the Heratherm oven.

Warranty





Thermo Electron LED GmbH warrants the operational safety and functions of the Heratherm ovens only under the condition that:

- the oven is operated and serviced exclusively in accordance with its intended purpose and as described in these operating instructions,
- the oven is not modified,
- only original spare parts and accessories that have been approved by Thermo Electron LED GmbH are used (third-party spares without Thermo Scientific approval void the limited warranty),
- inspections and maintenance are performed at the specified intervals,
- an installation verification test is performed on commissioning the oven for the first time and repeated after each inspection and repair activity.









The warranty is valid from the date of delivery of the oven to the customer.

Explanation of Safety Information and Symbols

Safety Notes and Symbols Used Throughout These Operating Instructions

	 <p>Indicates a hazardous situation which, if not avoided, will result in death or serious injuries.</p>
	 <p>Indicates a hazardous situation which, if not avoided, could result in death or serious injuries.</p>
	 <p>Indicates a situation which, if not avoided, could result in damage to equipment or property.</p>
	 <p>Is used for useful hints and information regarding the application.</p>

Additional Symbols for Safety Information

	Wear safety gloves!
	Wear safety goggles!
	Harmful liquids!
	Electric shock!
	Hot surfaces!
	Fire hazard!
	Explosion hazard!
	Suffocation hazard!
	Danger of tipping!

Symbols on the Oven



Observe operating instructions



VDE test mark



CE-conformity mark: confirms conformity according to EU Guidelines



Alarm contact

Intended Purpose of the Oven

Correct use

Built-in heating and drying ovens Heratherm OGH, OGH-S, OMH und OMH-S are to be operated up to a working temperature of max. 250 °C (482 °F), only.

Heratherm ovens are laboratory devices for heating applications, equipped with precision temperature control.

They are designed for heat treating samples or materials at operating temperatures between 50 °C (122 °F) and 330 °C (626 °F) (floor stand units: up to 250 °C/482 °F), including - for example, drying, ageing, analyzing, decomposing, burn-in, oxidizing, reducing, and preheating.

Heratherm ovens have been designed for installation and operation in the following environments:

- heat treatment;
- drying of material.

Incorrect Use

To avoid the risk of explosion do not load the oven with tissue, material, or liquids that:

- are easily flammable or explosive,
- release vapor or dust that forms combustible or explosive mixtures when exposed to air;

Safety Notes Standards and Directives

- release poisons;
- create a humid atmosphere;
- release dust;
- exhibit exothermic reactions;
- are pyrotechnical substances;
- exceed the specified hurdle load.

Standards and Directives

The oven complies with the following standards and guidelines:

- IEC EN 61010 - 1, IEC EN 61010 - 2 - 010
- Low Voltage Directive 2006/95/EC
- EMC Directive 2004/108/EC

Additionally, the oven is in compliance with many other international standards, regulations and directives not listed here. Should you have any questions regarding compliance with national standards, regulations and directives applicable for your country, please contact your Thermo Fisher Scientific sales organization.

Delivery of the Oven

Packaging

Heratherm ovens are delivered in a rugged packaging box. All packaging materials can be separated and are reusable:

Packaging materials

Packaging carton: Recycled paper

Foam elements: Styrofoam (CFC-free)

Pallet: Chemically untreated wood

Packaging film: Polyethylene

Packaging ribbons: Polypropylene

Acceptance Inspection

After the oven has been delivered, check the delivery immediately for:

- completeness,
- possible damage.

If components are missing or damage is found on the oven or the packaging, in particular damage caused by humidity and/or water, please notify the carrier as well as Technical Support immediately.

	 WARNING Risk of injury
	Should sharp edges have formed in damaged areas or elsewhere on the device, take all necessary precautions to protect personnel handling the oven. For example, have them wear protective gloves and other personal protection equipment.

Scope of Supply

Ovens

Quantity of components supplied (pieces)	OGH Series OGH-S Series	OMH-S Series OMH Series
Wire-mesh shelf	2	2
Support rail for shelf (only for table-top units)	0	2
Shelf support	4	4
Power cord	1	1
Connector, potential-free contact	1	1
Clip springs (only for table-top units)	0	2
Operating manual	1	1
Short reference guide	1	1

Installation

Ambient Conditions

Location Requirements

Built-in units of incubators can, heating and drying ovens must be operated with an air exhaust system and exhaust hose (only original Thermo accessory should be used).

For safety reasons, the installation space should be made of non-combustible materials, according to DIN 4102.

NOTE

During installation of built-in units, ensure that the escaping air will be safely discharged out of the installation space.

Use with Air Exhaust Systems

For built-in units, a temperature-resistant and corrosion-proof exhaust hose (only original Thermo accessory) should be used, which can be connected to the air exhaust port with a draft interrupter.

If several built-in units in a row are connected to a central air exhaust system (see illustration), a draft interrupter should be installed.

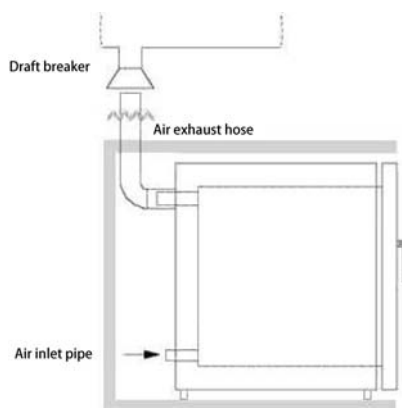

Fig. 1

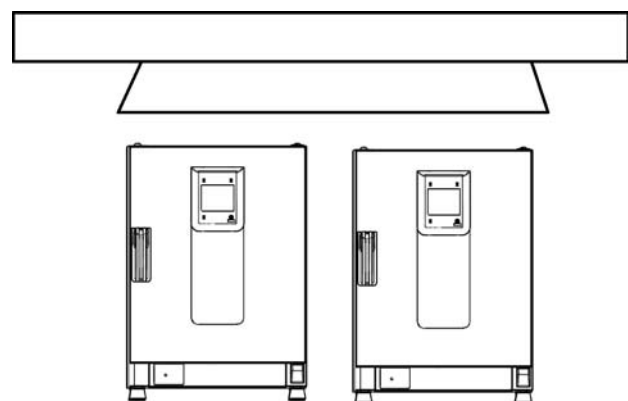

Fig. 2

The oven must only be operated in a location that meets all of the ambient condition requirements listed below:

- Draft-free and dry indoor location.
- The dust burden may not exceed the contamination category 2 based on EN 61010-1. Using the oven in an atmosphere with electrically conductive dust is prohibited.
- The minimal distance to adjacent surfaces must be observed on all sides (see section “Space Requirement” on page 3-4).
- The operating room must be equipped with appropriate ventilation.
- Solid, level, fire-proof surface and no flammable materials opposite to the rear panel of the oven.
- Vibration-proof substructure (floor stand, lab table) capable of bearing the dead weight of the oven and its accessories (particularly if two devices are stacked).
- The ovens have been designed for an operating height of up to 2000 m above sea level.
- Ambient temperature range from 18 °C to 32 °C / 64.4 °F to 89.6 °F.
- Relative humidity up to 80% (maximum; preferably 60-70%), non condensing.
- Condensation must be avoided - for example, after moving or transporting the device. Should condensation exist, wait until the moisture has evaporated completely before connecting the oven to a power source and powering up.
- Avoid direct exposure to sunlight.
- Devices that produce excessive amounts of heat must not be placed near the oven.
- To avoid drying operation without an appropriate fresh air supply make sure that the air inlet (which may be equipped with an optional fresh air filter) is not obstructed or blocked by any adjacent objects.
- Power line voltage variations must not exceed $\pm 10\%$ of the nominal voltage.
- Transient overvoltages must not exceed the values usually encountered throughout the power supply network. The nominal transient overvoltage level shall be the surge withstand voltage according to overvoltage category II of IEC 60364-4-443.
- Consider installing one dedicated upstream circuit breaker per oven to avoid multiple device failures in case of an electrical fault.

Intermediate Storage

When the oven is placed in intermediate storage, which is permissible for a maximum of four weeks, make sure that the ambient temperature is between 20 °C to 60 °C (68 °F to 140 °F) and the maximum relative humidity does not exceed 90%, non-condensing.

Room Ventilation

Heat dissipating from the oven during continuous operation may cause a change in the room climate.

- Therefore, the oven must only be installed in rooms with sufficient ventilation.
- Do not install the oven in room recesses without ventilation.
- When several devices are to be placed in the same room, additional ventilation may have to be provided as necessary.
- To avoid any impact of the heat dissipated by the oven on the ambient climate the room must be vented by means of a laboratory-grade ventilation system that complies with applicable local and national health and safety regulations and has sufficient capacity.
- If excessive temperatures tend to occur in the operating room, be sure to provide a thermal protection means that cuts out the power supply to mitigate the impact of overtemperature scenarios.

Use with Air Exhaust Systems

When the oven is connected to an air exhaust system be sure to adjust its air flow so the temperature distribution pattern throughout the oven's workspace remains unchanged and precision temperature control is maintained.

Before using existing piping in the building to exhaust hot air from the oven, be sure that such exhaust piping is made of heat-resistant material, so it will not overheat, melt and/or cause a fire.

The oven's outer surfaces and its air exhaust piping may become hot, so be sure to maintain the proper spacing from walls and ceilings specified by local building codes and/or fire protection regulations.

- Mark hot exhaust air piping with appropriate hot surface warning signs or restrict access to such piping altogether to avoid the risk of injury through contact with hot surfaces.

Space Requirement

For built-in units following clearances should be kept:

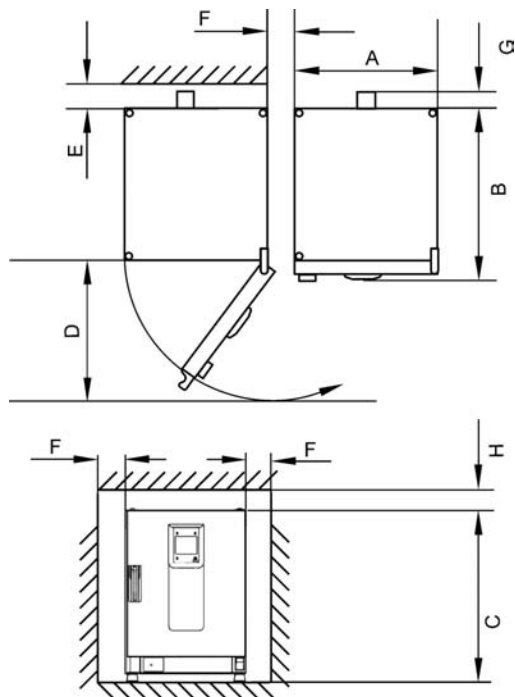

Fig. 3

A, B, C and D see Operating Instructions of the unit.

E (mm/inch)	F (mm/inch)	G (mm/inch)	H (mm/inch)
100 / 4	50 / 2	80 / 3.2	30 / 1.2

Installation Built-in Units

IGS	Clearances, as Fig. 3, without exhaust hose.
IMH/IMH-S	Clearances, as Fig. 3, Close air port with plug, supplied with the unit.
OGS/OMS	Clearances, as Fig. 3, with additional space to operate to air slide, with air exhaust system and exhaust hose Ø 40 mm (1.58 in)/1.5 m (59 in) (original Thermo accessory), shortened to required length, installed according to Fig. 1 and 2.
OGH/OGH-S OMH/OMH-S	Clearances, as Fig. 3, with air exhaust system and exhaust hose Ø 40 mm (1.58 in)/1.5 m (59 in) (original Thermo accessory), shortened to required length, installed according to Fig. 1 and 2, Operating temperature up to max. 250 °C (482 °F).



After connecting the built-in unit to the electrical power supply, avoid damaging the power cord, then sliding into the installation position.

When installing the oven, make sure that the installation and supply connections remain freely accessible.

The specified side clearances represent minimum distances.

Table-top units

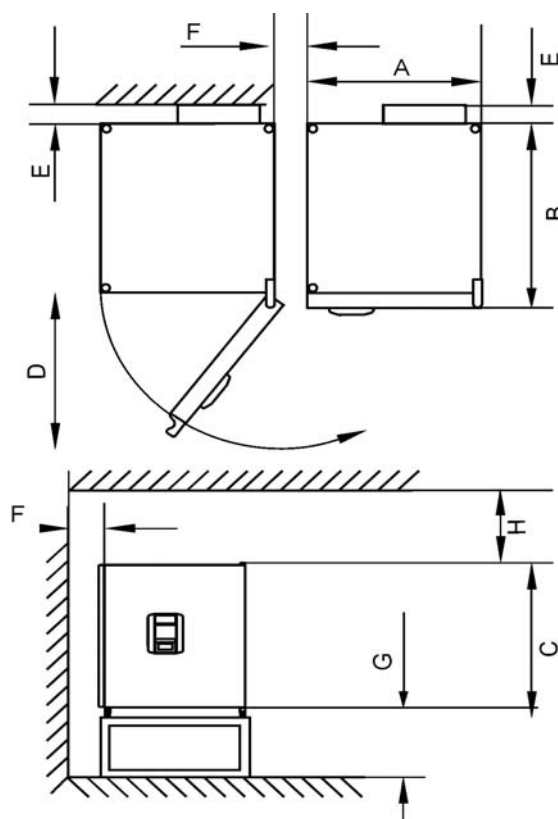

Figure 3-1 Table-top oven units, dimensions and required clearances

Table 3-1 Heratherm Oven Dimensions

Model	A (mm/inch*)	B (mm/inch)	C (mm/inch)	D (mm/inch)
OMH 60	530 / 20.8	565 / 25.2	720 / 28.3	540 / 21.3
OMH 100	640 / 25.2	565 / 25.2	820 / 32.3	650 / 25.6
OMH 180	640 / 25.2	738 / 29.1	920 / 36.2	650 / 25.6
OMH 60-S	530 / 20.8	565 / 25.2	720 / 28.3	540 / 21.3
OMH 100-S	640 / 25.2	565 / 25.2	820 / 32.3	650 / 25.6
OMH 180-S	640 / 25.2	738 / 29.1	920 / 36.2	650 / 25.6

*Dimensions in inches are rounded equivalents specified for information only. Depth of handle /display (66 mm/2.6 in) not included in overall depth specified; height of adjustable feet (36 mm/1.4 in) not included in overall height specified.

Table 3-2 Required Clearances

E (mm/inch)	F (mm/inch)	G (mm/inch)	H (mm/inch)
80 / 3.2	50 / 2	300 / 12	300 / 12

Floor stand units

400 liter units

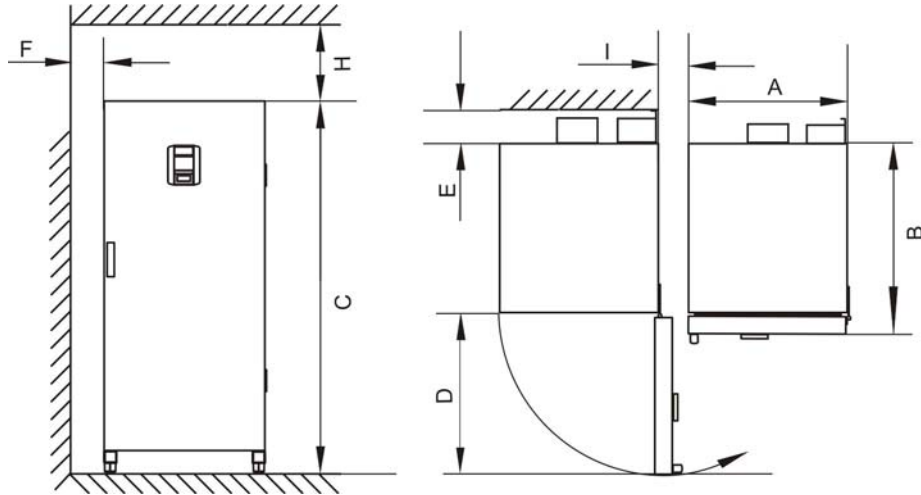

Figure 3-2 Floor stand ovens, dimensions and required clearances

Table 3-3 Oven Dimensions

Model	A (mm/inch)	B (mm/inch)	C (mm/inch)	D (mm/inch)
OMH 400	755 / 29.7	770 / 30.3	1655 / 65.2	810 / 31.9

* Depth of handle /display (66 mm/2.6 in) not included in overall depth specified. The width of the hinge (23 mm) is not included in the overall width.

Table 3-4 Required clearances

E (mm/inch)	F (mm/inch)	H (mm/inch)	I (mm/inch)
120 / 4.7	50 / 2.0	200 / 7.9	200 / 7.9

750 liter units

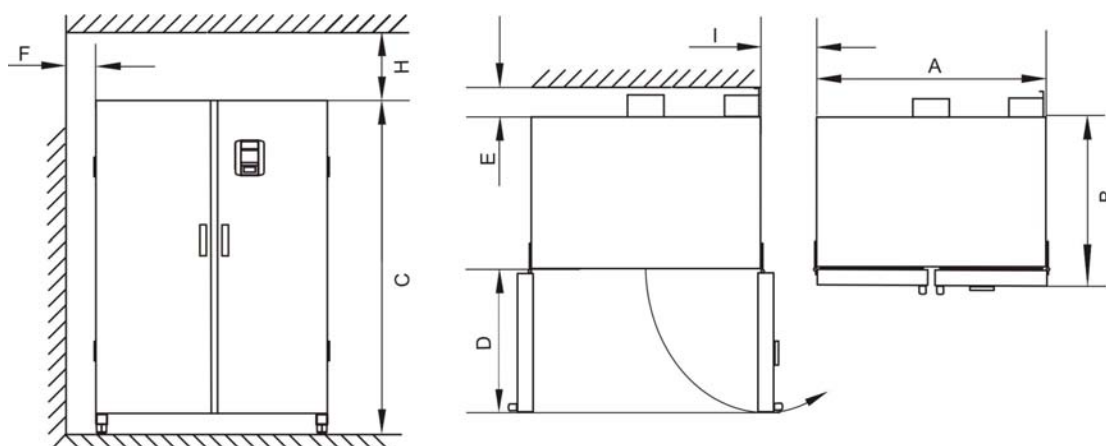

Figure 3-3 Floor stand ovens, dimensions and required clearances

Table 3-5 Oven Dimensions

Model	A (mm/inch)	B (mm/inch)	C (mm/inch)	D (mm/inch)
OMH 750	1215 / 47.8	770 / 30.3	1655 / 65.2	670 / 26.4

* Depth of handle /display (66 mm/2.6 in) not included in overall depth specified. The width of the hinge (23 mm) is not included in the overall width.

Table 3-6 Required clearances

E (mm/inch)	F (mm/inch)	H (mm/inch)	I (mm/inch)
120 / 4.7	50 / 2.0	200 / 7.9	350 / 13.8

Transport

Table-top units

For transport, do not lift the oven using the doors or components attached to the oven as lift points.

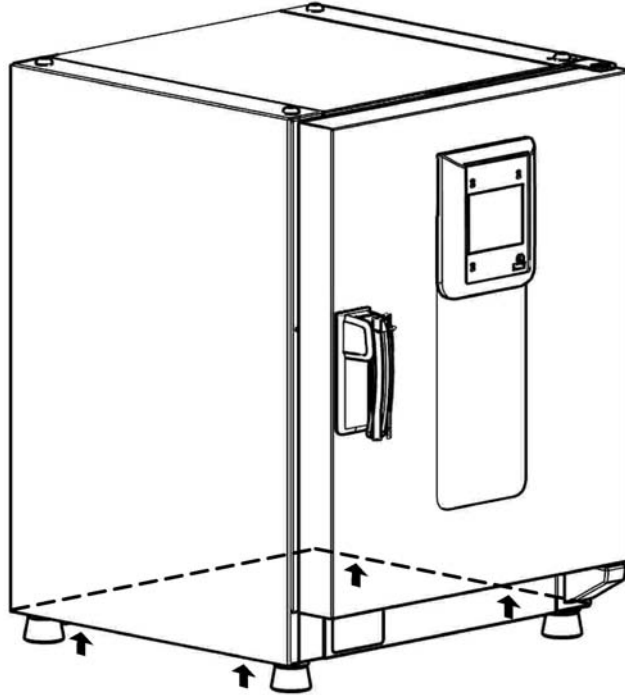



Figure 3-4 Lift Points



	 <p>CAUTION Heavy loads! Lift with care!</p> <p>To avoid injury through physical strain, such as strain traumata and slipped discs, do not attempt to lift the oven alone!</p> <p>To avoid injury through dropped loads, be sure to wear Personal Protection Equipment, such as safety shoes, when lifting the oven.</p> <p>To avoid crushing your fingers or hands (particularly in a closing door) or damaging the oven, do not use any other lift points than those indicated in the illustration above.</p>
--	---

Floor stand units



The floor stand units come equipped with four (4) casters. The lever for releasing the caster is located above the locking lever. After positioning the unit in its installation location ensure that the locking levers are pressed down on the casters.

To ensure the degree of stability specified by safety requirements the front casters must be turned so that they are facing forward after the unit has been positioned in its installation location and the locking levers pressed down on these casters.

	<div style="border: 1px solid black; padding: 5px; margin-bottom: 10px;">  Danger of tipping when moving! </div> <p>Before moving the unit, ensure that it has been unplugged.</p> <p>Move the Heratherm floor stand units with caution.</p> <p>Quick starts and stops can result in tipping!</p> <p>Always ensure that the doors are closed when moving the unit.</p>
--	--

Stacking Kit

The stacking adapter is available only for table-top units.

Material Number	Description
50126665	Stacking adapter Heratherm 60L
50126666	Stacking adapter Heratherm 100L
50126667	Stacking adapter Heratherm 180L

Scope of Delivery:

1 stacking adapter

1 anti-tilt anchor

1 plastic bag with 2 stacking feet and 2 M4x16 Torx screws.

Required Tools:

Slotted screwdriver 5,5x100 or Torx screwdriver 20x100.

Installing the Stacking Feet

Remove the left and right blank plugs at the top blank.

Install the stacking feet with the enclosed screws using a slotted or Torx screwdriver.

Installing the Stacking Adapter

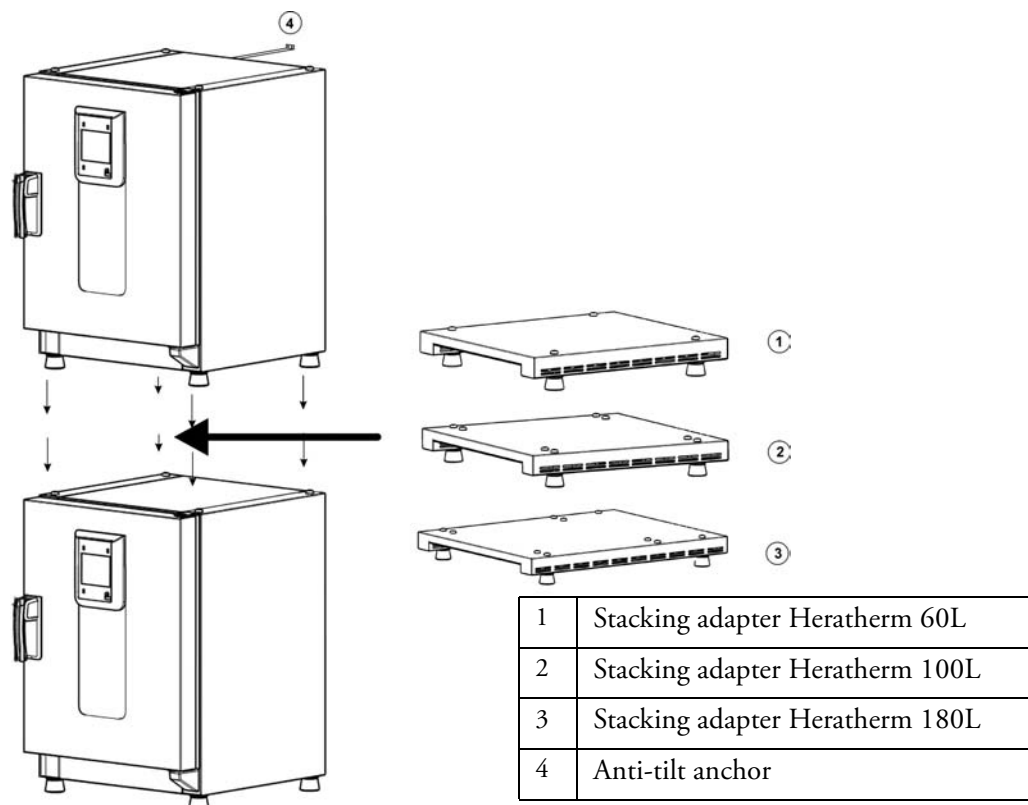

Stack as follows when using a stacking adapter (numbers denote oven volumes in liters):

- for 60/100/180 on 180 use stacking adapter Heratherm 180L,
- for 60/100/100 on 180 use stacking adapter Heratherm 100L,
- for 60/60/100 on 180 use stacking adapter Heratherm 60L,

To prevent the top oven from slipping and dropping down, the following requirements must be fulfilled before devices may be stacked:

- Only two units may be stacked together. When stacking devices with the same type of enclosure, yet with a different footprint the device with the smaller footprint must be placed on top of the one with the larger footprint at all times.
- The bottom device must be correctly levelled.
- Be sure to use the appropriate stacking adapter.
- The levelling feet on the top device must be screwed in all the way.
- The levelling feet of the top device must be aligned with and placed exactly on the stacking pads of the stacking adapter.
- The anti-tilt anchor must be installed on the top device.

Installing the Anti-tilt Anchor

Table-top units

The anti-tilt anchor secures the top device in a stack to a solid part of a building. The anti-tilt anchor is to be mounted on the side opposite of the door hinges.

Bend the fixing tabs of the anti-tilt anchor up on one side and down on the other by an angle of approx. 90°.

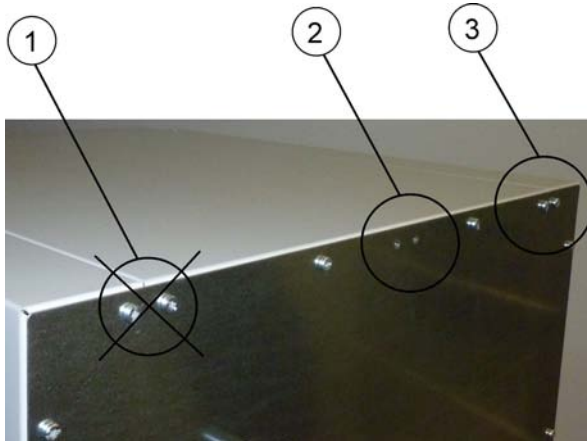

1. Do not use this position if the door is hinged on this side. Right-hand hinges represent the standard configuration.
2. Preferred position.
3. Alternative position. Do not use if the door is hinged on this side.

Remove the bracket screws. Use the preferred position, if possible.

Fix the anti-tilt anchor with the bracket side down to the unit (see figure).

Position the unit with the anti-tilt anchor to in an angle of approx. 90° +/- 20%.

Take care that the stacking feet of the unit are still in correct place on the lower unit or on the stacking adapter.

Fix the anti-tilt anchor to a solid part of the building.

Floor stand units

NOTE

Anti-tilt anchors

Heratherm floor stand units must always be attached to the wall using two (2) retaining brackets on the outer left and right side on the back of the unit.



Remove the screws.

Attach the end of the retaining bracket that is facing downward to the unit.

Align the device at roughly 90°, +/-20° to the retaining bracket.

Affix the retaining bracket to the wall.



CAUTION

Unsafe part of the building!

Install the anti-tilt anchor to a solid part of the building, which is able for shoring loads.

The installation has to be carried out by qualified personnel only.

The connection to the building must be carried out with appropriate screws and dowels according to the consistence of the building part.

Additionally, the following caution notes must be heeded at all times:



CAUTION

Risk of overheating with stacked devices

To avoid the risk of electrical components and the outer enclosure overheating or temperature control failing due to insufficient ventilation, do not exceed the specified stacking height!

	<p>Risk of tipping and dropping of stacked devices</p>
<p>You should be aware at all times that stacked devices do not form a stable unit, even when the stacking pads and frames are used correctly. The top device may tip over and drop down when being transported in a stack. To avoid injury to persons and damage to equipment, do not attempt to move stacked devices as a unit! Separate and move each device one by one, then restack them.</p>	
<p>Thermo Scientific accepts no responsibility or liability whatsoever with regard to stacked third party devices; this is at the user's own risk.</p>	

Floor stand unit spacers

The spacer on the electrical module must be pulled out and fixed in place before installing the floor stand unit at its installation location.



- 1 Loosen the 2 screws
- 2 Pull out the spacer and slide the screws into the recesses
- 3 Tighten the two screws

Product Description

This section describes Heratherm advanced protocol ovens for high-end laboratory applications, which are available in four different versions distinguished by convection method and safety level:

- Heratherm OGH Series advanced protocol gravity convection ovens (see “[Heratherm OGH Series Oven Overview](#)” on [page 4-1](#))
- Heratherm OGH-S Series advanced protocol security natural convection ovens come equipped with the features also found in OGH Series devices, including additional safety functions for the customer (see “[Heratherm OGH-S Series Oven Overview](#)” on [page 4-3](#)):
- Heratherm OMH Series (OMH is brief for Oven with Mechanical convection) advanced protocol fan convection ovens come equipped with the following features (see “[Heratherm OMH Series Oven Overview](#)” on [page 4-5](#)):
- Heratherm OMH-S Series advanced protocol fan convection ovens come equipped with the following features and additional safety functions for the customer (see “[Heratherm OMH-S Series Oven Overview](#)” on [page 4-12](#)):

Heratherm OGH Series Oven Overview

Heratherm OGH Series (OGH is brief for Oven with Gavity convection) advanced protocol natural convection ovens come equipped with the following features:

- high-precision work space temperature control, adjustable in steps of one degree up to 330 °C/626 °F;
- boost feature for speed-heating a cold and empty oven;
- an electrically driven damper for venting the work space, adjustable on the control panel;
- countdown, fixed-time, and weekly timers for timed process control;
- two wire-mesh shelves;
- user program support for automating process control;
- an access port for tubing, sensor leads, etc.

Product Description
Heratherm OGH Series Oven Overview

The individual features of OGH Series ovens are shown in the figures below.

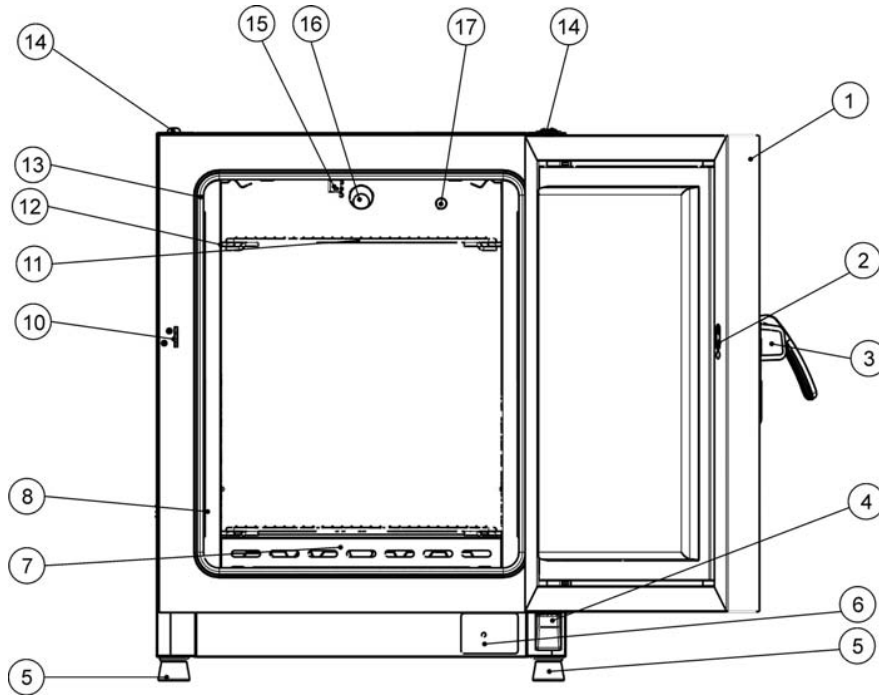

Figure 4-1 Heratherm OGH 60/ OGH 100/ OGH 180 Series Front View

- [1] Outer door
- [2] Door latch cutout
- [3] Door latch and handle
- [4] Door hinge, lower
- [5] Levelling foot
- [6] Nameplate
- [7] Air baffle, bottom
- [8] Air baffle, side
- [9]
- [10] Door hook catch
- [11] Wire-mesh shelf
- [12] Support rail for wire mesh shelf
- [13] Door seal
- [14] Stacking pad
- [15] Temperature sensor
- [16] Exhaust air tube
- [17] Access port

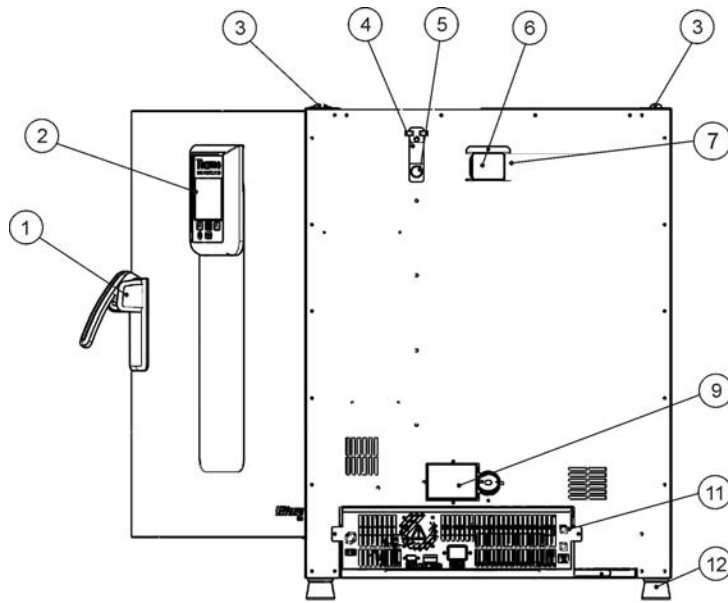

Figure 4-2 Heratherm OGH 60/ OGH 100/ OGH 180 Series Rear View

- [1] Door latch and handle
- [2] Control panel
- [3] Stacking pad
- [4] Access port slide
- [5] Access port
- [6] Spacer
- [7] Air outlet aperture
- [8]
- [9] Air inlet flap, with electrical drive
- [10] -
- [11] Electronics compartment
- [12] Levelling foot

Heratherm OGH-S Series Oven Overview

Heratherm OGH-S Series (OGH-S is brief for Oven with Gravity convection with exacting Safety requirements) advanced protocol security natural convection ovens come equipped with the features also found in OGH Series devices, including:

- high-precision work space temperature control, adjustable in steps of one degree up to 330 °C/626 °F;
- boost feature for speed-heating a cold and empty oven;
- an electrically driven damper for venting the work space, adjustable on the control panel;
- countdown, fixed-time, and weekly timers for timed process control;
- two wire-mesh shelves;
- an access port for tubing, sensor leads, etc.;
- user program support for automating process control;

Additionally, OGH-S Series ovens offer the following extra functionality:

- a lockable door to secure a running process against unauthorized access;
- door switch and indicator on the control panel to indicate that the door is open;

Product Description
Heratherm OGH-S Series Oven Overview

- a sample protection feature that reduces the oven's work space temperature to a safe level when the internal controller is subject to an error condition;
- monitoring of lower temperature;
- preparation for sample sensor accessory;
- ECO drying support (requires optional sample sensor)

The individual features of OGH-S Series ovens are shown in [figure 4-5](#) and [figure 4-6](#) below.

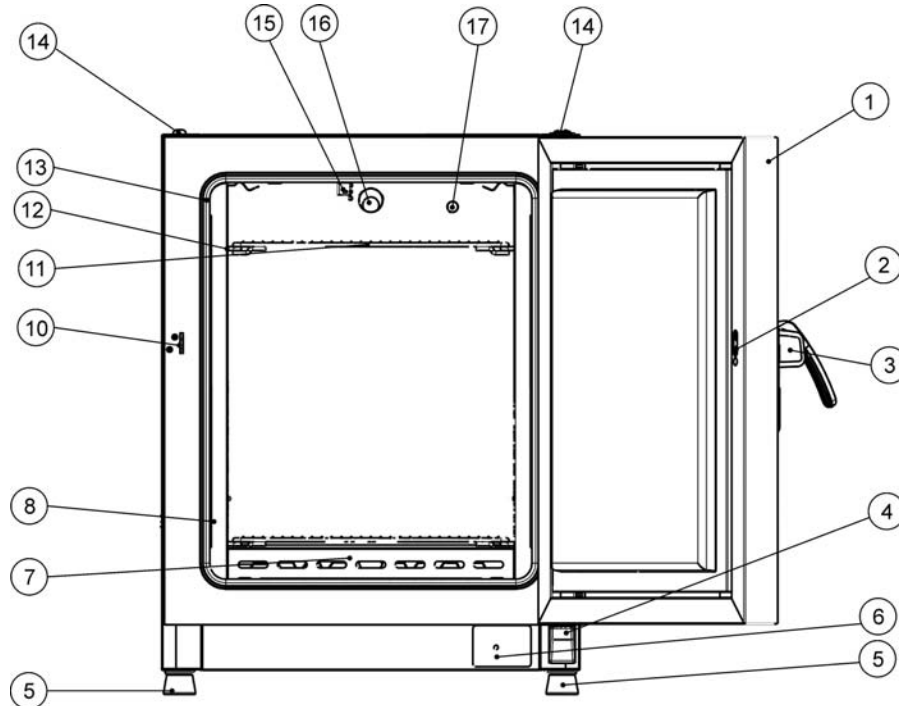

Figure 4-3 Heratherm OGH-S Front View

- [1] Outer door
- [2] Door switch
- [3] Door latch and handle
- [4] Door hinge, lower
- [5] Levelling foot
- [6] Nameplate
- [7] Air baffle, bottom
- [8] Air baffle, side
- [9]
- [10] Door hook catch
- [11] Wire-mesh shelf
- [12] Support rail for wire mesh shelf
- [13] Door seal
- [14] Stacking pad
- [15] Temperature sensor
- [16] Exhaust air tube
- [17] Access port

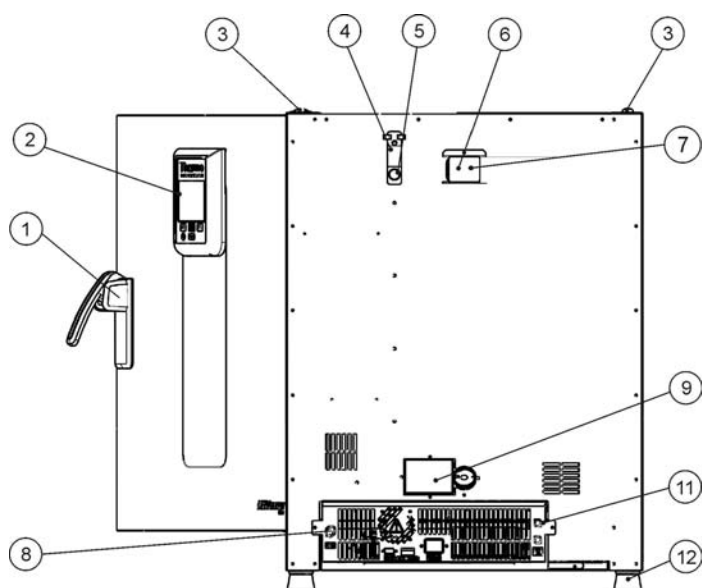

Figure 4-4 Heratherm OGH-S Rear View

- [1] Door latch and handle
- [2] Control panel
- [3] Stacking pad
- [4] Access port slide
- [5] Access port
- [6] Spacer
- [7] Air outlet aperture
- [8] Sample sensor connection
- [9] Air inlet flap, with electrical drive
- [10] -
- [11] Electronics compartment
- [12] Levelling foot

Heratherm OMH Series Oven Overview

Heratherm OMH Series (OMH is brief for Oven with Mechanical convection) advanced protocol mechanical convection ovens come equipped with the following features:

- high-precision work space temperature control, adjustable in steps of one degree up to 330 °C/626 °F (floor stand unit: up to 250 °C/482 °F);
- boost feature for speed-heating a cold and empty oven (only for table-top units);
- a variable-speed fan for optimizing temperature uniformity throughout the work space;
- an electrically driven damper for venting the work space, adjustable on the control panel;
- countdown, fixed-time, and weekly timers for timed process control;
- two wire-mesh shelves;
- an access port for tubing, sensor leads, etc.
- user program support for automating process control;
- door switch for floor stand units

Product Description
Heratherm OMH Series Oven Overview

The individual features of OMH Series ovens are shown in the figures below.

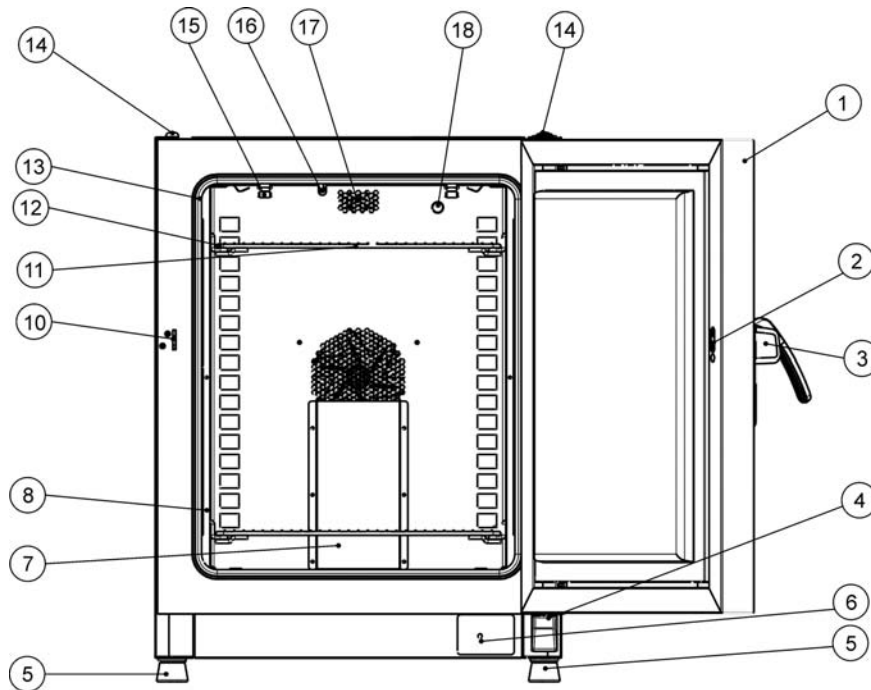

Figure 4-5 Heratherm OMH 60/ OMH 100/ OMH 180 Series Front View

- [1] Outer door
- [2] Door latch cutout
- [3] Door latch and handle
- [4] Door hinge, lower
- [5] Levelling foot
- [6] Nameplate
- [7] Air baffle, top piece
- [8] Support rail for wire mesh shelf
- [9]
- [10] Door hook catch
- [11] Wire-mesh shelf
- [12] Support rail for wire mesh shelf
- [13] Door seal
- [14] Stacking pad
- [15] Spring for support rail
- [16] Temperature sensor
- [17] Exhaust air tube
- [18] Access port

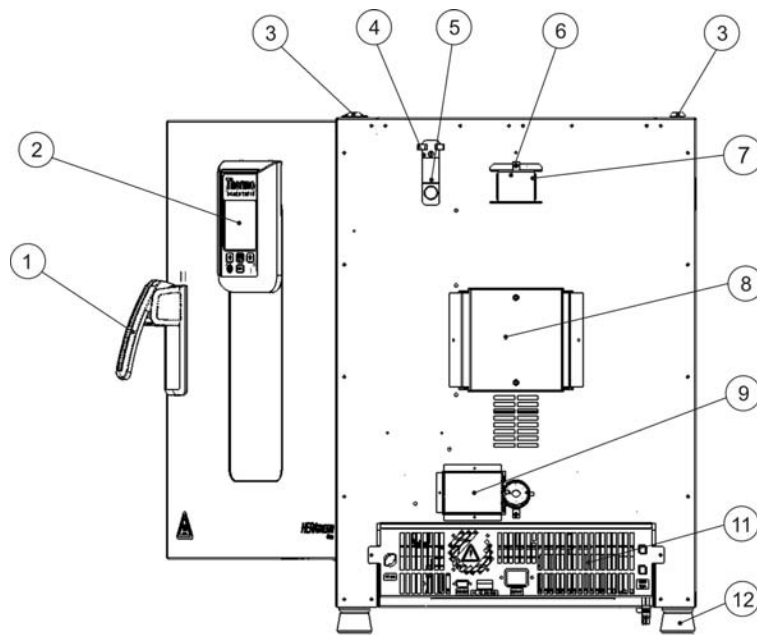

Figure 4-6 Heratherm OMH 60/ OMH 100/ OMH 180 Series Rear View

- [1] Door latch and handle
- [2] Control panel
- [3] Stacking pad
- [4] Access port slide
- [5] Access port
- [6] Exhaust air tube
- [7] Air outlet aperture
- [8] Fan
- [9] Air inlet flap, with electrical drive
- [10] -
- [11] Electronics compartment
- [12] Levelling foot

Product Description
Heratherm OMH Series Oven Overview

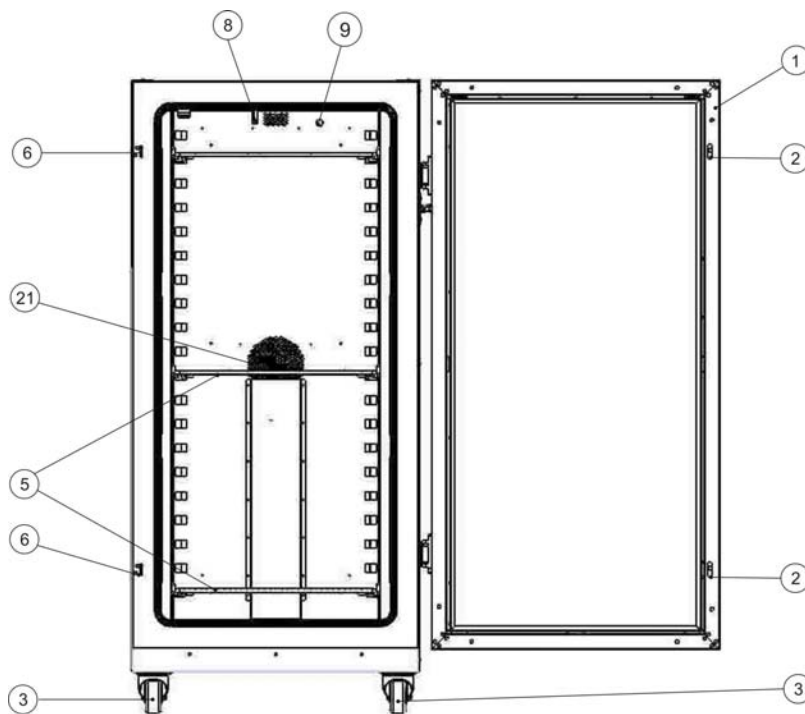

Figure 4-7 Heratherm OMH 400 Series Front View

- [1] Outer door
- [2] Door latch
- [3] Unit caster
- [4] -
- [5] Wire-mesh shelf
- [6] Door hook catch
- [7] -
- [8] Temperature sensor
- [9] Access port
- [10] -
- [11] -
- [12] -
- [13] -
- [14] -
- [15] -
- [16] -
- [17] -
- [18] -
- [19] -
- [20] -
- [21] Fan opening, air baffle

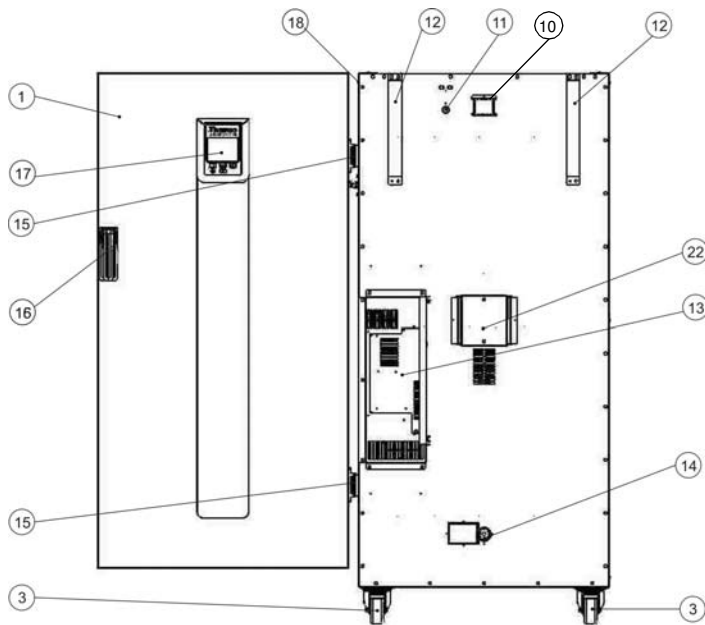

Figure 4-8 Heratherm OMH 400 Series Rear View

- [1] Outer door
- [2] -
- [3] Unit caster
- [4] -
- [5] -
- [6] -
- [7] -
- [8] -
- [9] -
- [10] Exhaust air tube
- [11] Access port
- [12] Anti-tilt anchor
- [13] Electronics compartment
- [14] Air inlet flap, with electrical drive
- [15] Hinge, right
- [16] Handle
- [17] Display
- [18] Nameplate
- [19] -
- [20] -
- [21] -
- [22] Fan

Product Description
Heratherm OMH Series Oven Overview

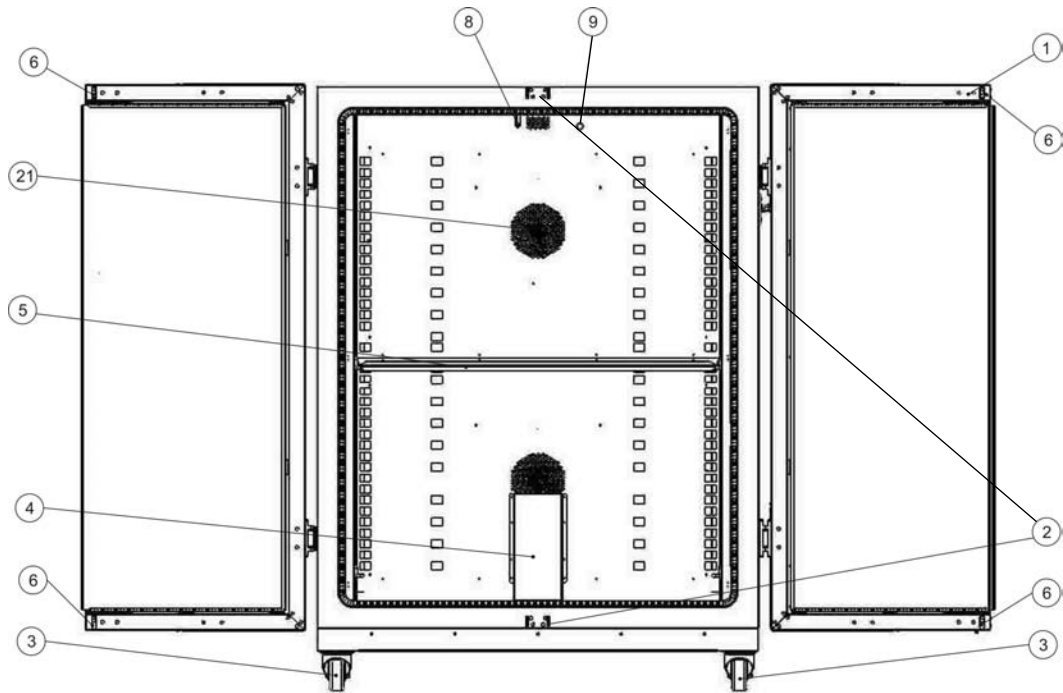

Figure 4-9 Heratherm OMH 750 Series Front View

- [1] Outer door
- [2] Door hook catch
- [3] Unit caster
- [4] Air baffle
- [5] Wire-mesh shelf
- [6] Door latch
- [7] -
- [8] Temperature sensor
- [9] Access port
- [10] -
- [11] -
- [12] -
- [13] -
- [14] -
- [15] -
- [16] -
- [17] -
- [18] -
- [19] -
- [20] -
- [21] Fan opening, air baffle

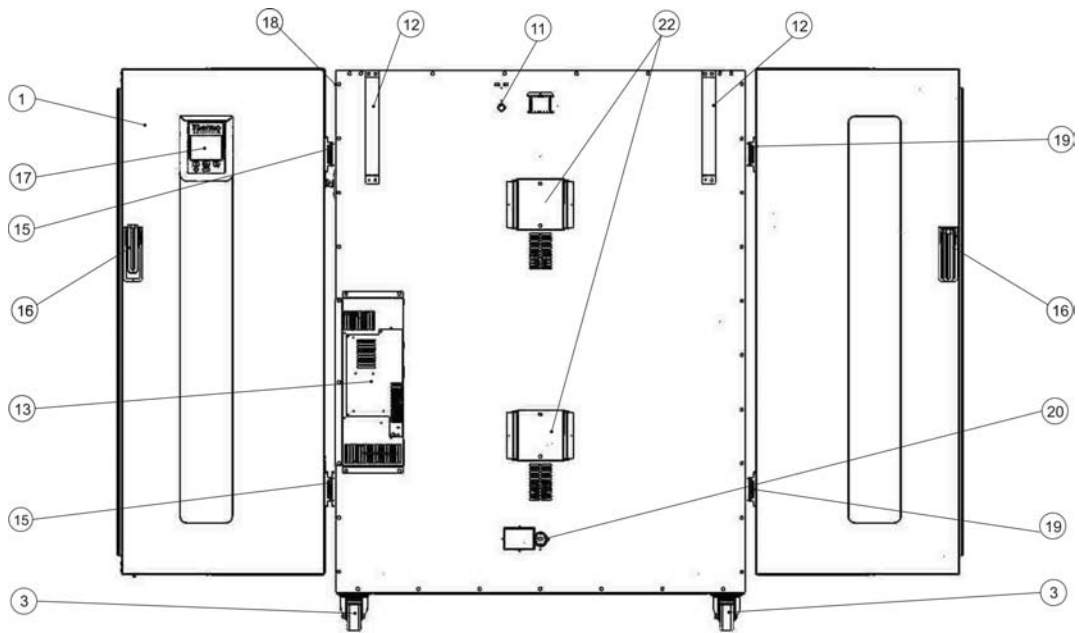

Figure 4-10 Heratherm OMH 750 Series Rear View

- [1] Outer door
- [2] -
- [3] Unit caster
- [4] -
- [5] -
- [6] -
- [7] -
- [8] -
- [9] -
- [10] -
- [11] Access port
- [12] Anti-tilt anchor
- [13] Electronics compartment
- [14] -
- [15] Hinge, right
- [16] Handle
- [17] Display
- [18] Nameplate
- [19] Hinge, left
- [20] Air inlet flap, with electrical drive
- [21] -
- [22] Fan

Heratherm OMH-S Series Oven Overview

Heratherm OMH-S Series (OMH-S is brief for Oven with Mechanical convection for High-end laboratory applications with exacting Safety requirements) advanced protocol security mechanical convection ovens come equipped with the features also found in OMH Series devices, including:

- high-precision work space temperature control, adjustable in steps of one degree up to 330 °C/626 °F;
- boost feature for speed-heating a cold and empty oven;
- a variable-speed fan for optimizing temperature uniformity throughout the work space
- an electrically driven damper for venting the work space, adjustable on the control panel;
- countdown, fixed-time, and weekly timers for timed process control;
- two wire-mesh shelves;
- an access port for tubing, sensor leads, etc.;
- user program support for automating process control;

Additionally, OMH-S Series ovens offer the following extra functionality:

- a lockable door to secure a running process against unauthorized access;
- door switch and indicator on the control panel to indicate that the door is open;
- a sample protection feature that reduces the oven's work space temperature to the setpoint when the heating control system is subject to an error condition.
- Monitoring of lower temperature
- preparation for sample sensor accessory;
- ECO drying support (requires optional sample sensor)

The individual features of OMH-S Series ovens are shown in [figure 4-16](#) and [figure 4-17](#) below.

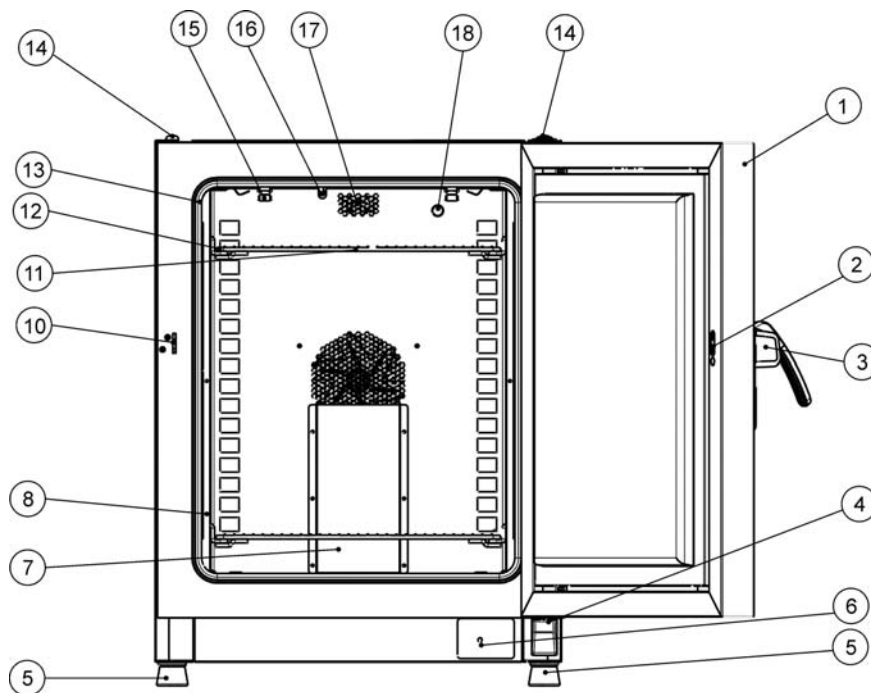

Figure 4-11 Heratherm OMH-S Front View

- [1] Outer door
- [2] Door switch
- [3] Door latch and handle
- [4] Door hinge, lower
- [5] Levelling foot
- [6] Nameplate
- [7] Air baffle, top piece
- [8] Shelf support
- [9] -
- [10] Door hook catch
- [11] Wire-mesh shelf
- [12] Support rail for wire mesh shelf
- [13] Door seal
- [14] Stacking pad
- [15] Spring for support rail
- [16] Temperature sensor
- [17] Exhaust air tube
- [18] Access port, exhaust air port

Product Description
Heratherm OMH-S Series Oven Overview

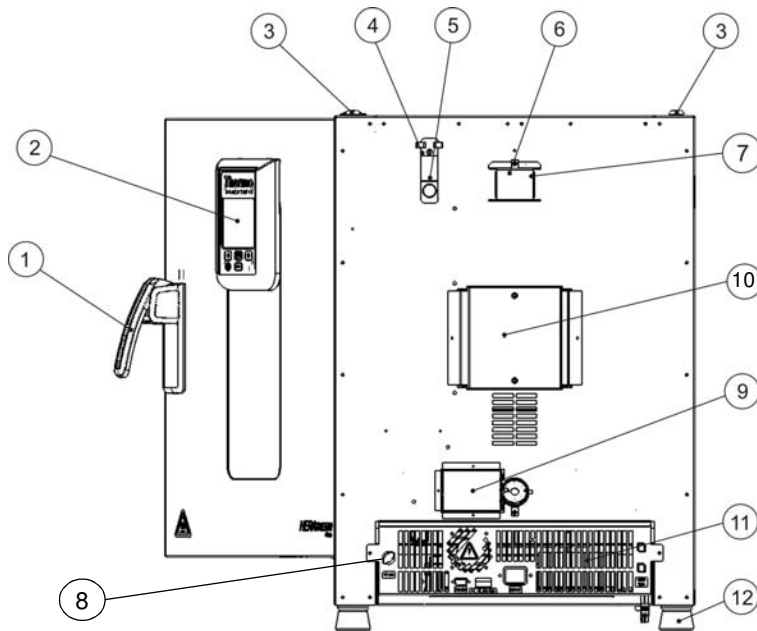

Figure 4-12 Heratherm OMH-S Rear View

- [1] Door latch and handle
- [2] Control panel
- [3] Stacking pad
- [4] Access port slide
- [5] Access port
- [6] Spacer
- [7] Air outlet aperture
- [8] Sample sensor connection
- [9] Air inlet flap, with electrical drive
- [10] Fan
- [11] Electronics compartment
- [12] Levelling foot

Safety Devices

The oven is equipped with the following safety features:

- a sample protection feature that safeguards the samples against destruction through overheating in case of controller failure;
- an overheat protection cut-out feature that shuts down the oven completely when excessive temperatures occur in the workspace;
- dual fuses rated at 16 amperes.

Operating Environment

To ensure undisturbed operation, the ambient temperature in the operating room must be at least 18 °C (64.4 °F). The heating system controls the temperature in the oven's workspace of 50 °C/122 °F up to the maximum of 330 °C/626 °F. (floor stand unit: 250 °C/482 °F)

Door switch

Heratherm OGH 60/100/180-S and Heratherm OMH 60/100/180/400/750 ovens come with a door switch integrated into the latch mechanism. If the door switch is activated by opening the door, heating operations in the work space are suspended and an icon is illuminated in the display window (see D4 in [figure 7-1](#) on [page 7-1](#)).

If the door remains open for more than 30 seconds, a short audible alarm is sounded in addition to the icon in the display window. If the door is left open for more than 10 minutes, an audible alarm is sounded, a "door open" (E001) alarm message appears in the display and is issued through the RS-232 interface, and the alarm relay is energized.

Sensing and Control System

The PT 100-type sensor for the control of the work space temperature and for the thermal protection [1] is mounted in the top panel of the work space compartment.

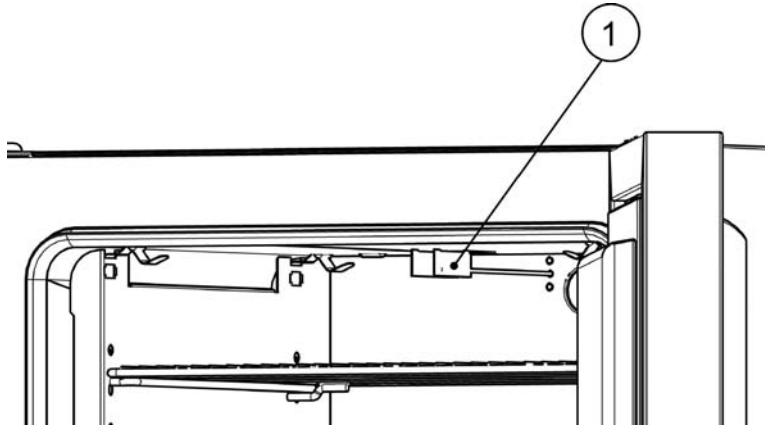

Figure 4-13 Sensor Mounting Location - OGH Series - Table-top units

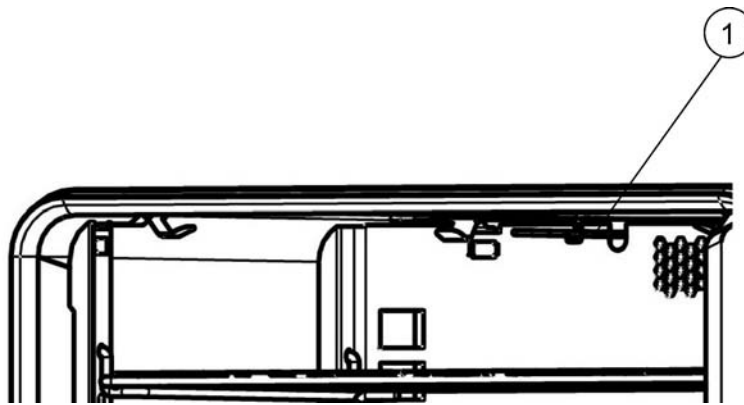

Figure 4-14 Sensor Mounting Location - OMH Series - Table-top units

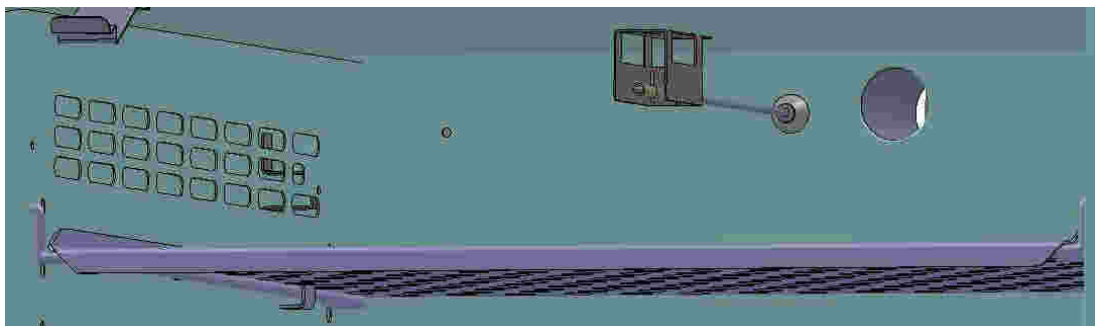

Figure 4-15 Sensor Mounting Location - OMH Series - Floor stand units

The work space temperature sensor provides the inputs to the oven's built-in controller, which continuously compares the measured values to the user-specified set value and adjusts the heaters according to the result.

	<div style="background-color: #0056b3; color: white; padding: 5px; font-weight: bold; font-size: 1.2em; margin-bottom: 5px;">NOTE</div> <p>Do not remove the protective hose from the sensor. Protect the sensor from mechanical damage.</p>
--	---

The unit features a thermal protection function that is factory-preprogrammed and not adjustable. It protects the samples in the work space from overheating: Thermal protection kicks in on a brief violation of the upper limit, based on the user-selected temperature set value, automatically reducing the work space temperature to the user-specified set value and allowing the heating process to continue even in case of a controller malfunction. If the thermal protection is activated, the error message (E111) “Temperature too high” appears in the display window and an audible alarm is sounded.

When the user acknowledges the error message, the red alarm icon (D4 in [figure 7-1](#) on [page 7-1](#)) is illuminated and the Temperature Set Value icon (see [table 7-3](#) on [page 7-4](#)) is highlighted by a red border to indicate that thermal protection has kicked in.

Data Communications & Alarm Interface

All signal connections are installed in the electrical interface panel at the rear of the oven.

RS 232 interface

The RS- 232 interface (left in [figure 4-16](#) below) may be used to connect ovens to the serial interface port of a computer to allow for the computer-aided acquisition and documentation of major operating parameters (temperature, error codes, etc.).



Figure 4-16 Signal Interfaces and Power Socket

Alarm contact

The oven can be connected to an on-site, external alarm system (such as a private branch telephone exchange, a facility monitoring system, visual or audible alarm indicators; see “[Wiring the Alarm Contact](#)” on [page 5-13](#)). For this purpose, the devices come with a pre-wired potential-free alarm contact (see [figure 4-16](#)). The alarm contact is energized whenever an error occurs in an internal control loop or the oven’s electrical circuits or hardware.

AC Power Socket

The device is connected to the AC supply mains via an IEC socket, which accepts a power cord with an IEC standard plug (see [figure 4-16](#)).

Fuses

Two 16 A slow-blow fuses mounted on the oven’s main electronic circuit board protect internal circuitry from the impact of excessive power consumption.

With product option “Viewing Windows with Workspace Lighting”, the lamps are protected with a 5 A fuse placed in the electronic compartment.

	 NOTE
	Replacement should only be carried out by skilled and authorized qualified personnel of electrotechnology/signal engineering!

	 NOTE	Fuse replacement
	The device fuses are not user-serviceable. When the oven exhibits the typical signs of a blown fuse (no response to pressing the On/Off button, control panel remains extinguished, no heating operation), call Customer Service to have the fuses replaced.	

Work Space Components

Inner Chamber

All components of the work space are made of corrosion-resistant stainless steel and have an absolutely smooth and easy-to-clean surface. Any embossings have a large radius.

Shelf System

The oven is supplied with two wire-mesh shelves. The shelf support rails have an alternating pattern of oblong and round perforations spaced evenly at 30 mm, allowing the shelf support brackets to be inserted without any room for error, yet in a very flexible way to accommodate different heights of sample containers. The shelves have an integrated tilt protection and withdrawal stop. For details on using the shelf system, see the section “Start-up” on [page 5-1](#).

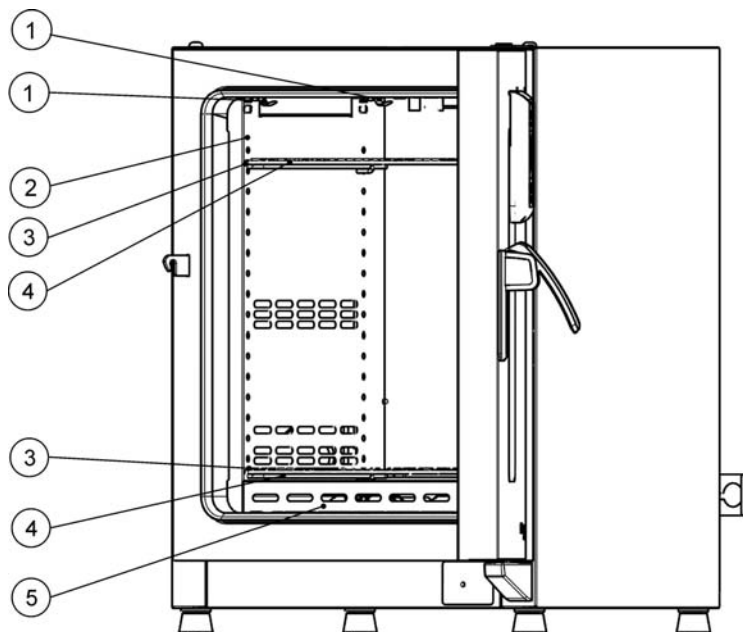

- [1] Retaining spring
- [2] Air baffle, side
- [3] Support rail for wire mesh shelf
- [4] Wire-mesh shelf
- [5] Air baffle, bottom

Figure 4-17 Shelf System - OGH Series and OGH-S Series Oven

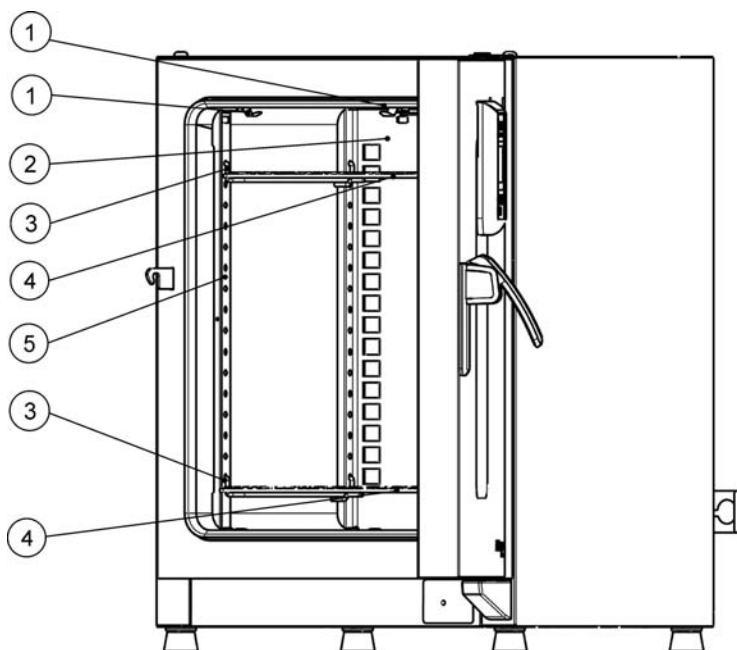

- [1] Retaining spring
- [2] Air baffle, rear
- [3] Support rail for wire mesh shelf
- [4] Wire-mesh shelves
- [5] Support rail

Figure 4-18 Shelf System - OMH Series and OMH-S Series Oven

Product Options of Table-top units

This section describes the options available for the Heratherm heating and drying ovens for high end laboratory applications.

Door Fitted with Viewing Windows and Workspace Lighting

Heratherm heating and drying ovens may be equipped with a Viewing Package. With devices of 60 and 100 liters workspace volume, this package consists of one viewing window plus workspace lighting, while devices with 180 liters are fitted with two viewing windows and workspace lighting.

The workspace lighting is not designed for use as a permanent illumination source. Use it for brief visual checks of the device's interior only. The View Package limits the operating temperature range of the heating and drying oven to 250 °C (482 °F).

Instructions for turning the workspace lighting on and off can be taken from the section "Light" on [page 7-16](#).

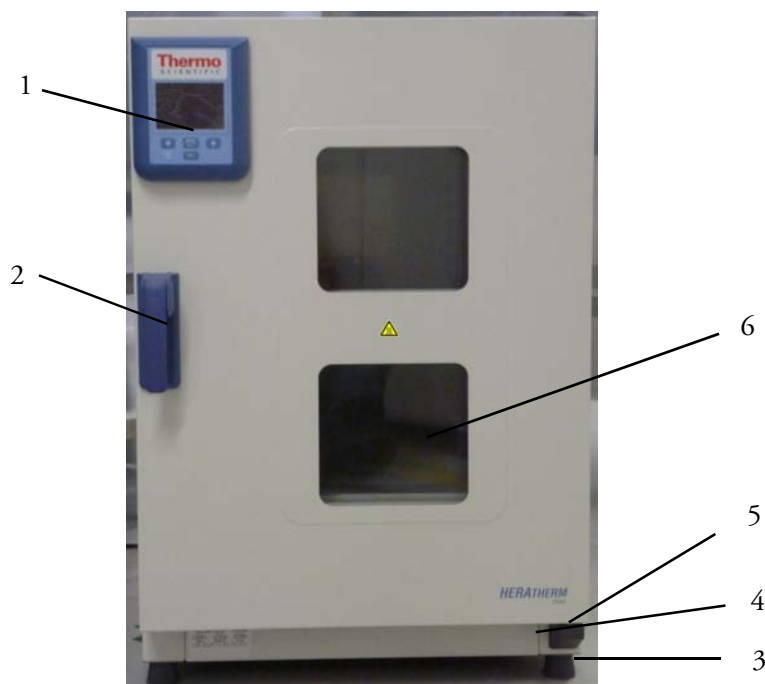

Figure 4-19 Viewing Package Front View

- [1] Control panel
- [2] Door latch and handle
- [3] Levelling foot
- [4] Nameplate
- [5] Door hinge, lower
- [6] Viewing window

Tube Access Ports of Table-top units

Heratherm heating and drying ovens may be equipped with additional tube access ports in the side and top panels.

Available tube access port options are listed in [table 4-1](#) below.

Table 4-1 Tube Access Ports for Heratherm Heating and Drying Ovens (Option)

Model	Side Panel Mounted Port, dia. in mm	Top Panel Mounted Port, dia. in mm
OGH and OGH-S	19 or 53	24 or 58
OMH and OMH-S	24 or 58	24 or 58

The tube access ports are mounted in fixed locations in the side and top panels (see [figure 4-20](#)).

Product Description
Tube Access Ports of Table-top units

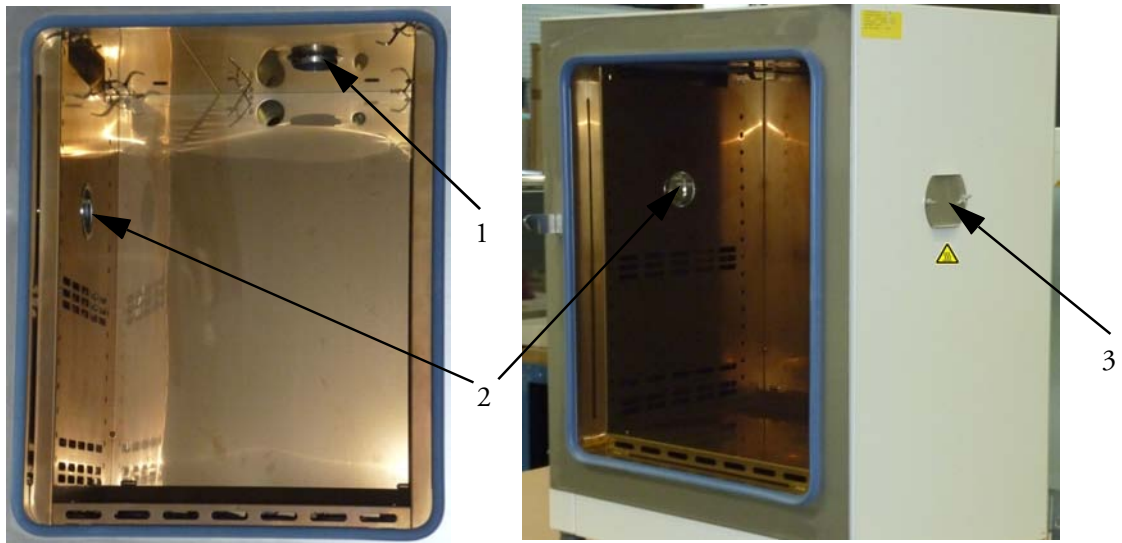

Figure 4-20 Tube Access Ports

- [1] Top panel mounted tube access port
- [2] Side panel mounted tube access port
- [3] Sealing cap for side panel mounted tube access port

Once the cables, tubes or other conduits have been inserted, the tube access ports must be padded with the heat-resistant fiber pads shipped with the device and the cap must be mounted to seal the port as far as possible.

		Risk of Burning on Hot Surface
The surface around the tube access ports may become extremely hot.		

Start-up

Table-top units

Installing the Shelf System

The installation of the shelf system does not require any tools. The support rails are secured in place by spring action. Once the shelf support brackets have been inserted into the rails, the wire-mesh shelves can be simply pushed onto their support hooks to complete the installation.

NOTE

The support rails of the floor stand units cannot be removed.

Initial installation

Heratherm OGH and OGH-S Series ovens have the shelving support rails integrated with the air baffles, which are readily pre-installed when the devices are shipped from the factory.

Heratherm OMH and OMH-S Series ovens come with separate support rails, which need to be installed as follows:

- Peel off the protective foil from the support rails.
- Push the retaining spring [1] into the guide on the support rail [2], making sure that the locking nub [3] on the retaining spring safely engages with the matching hole in the support rail.

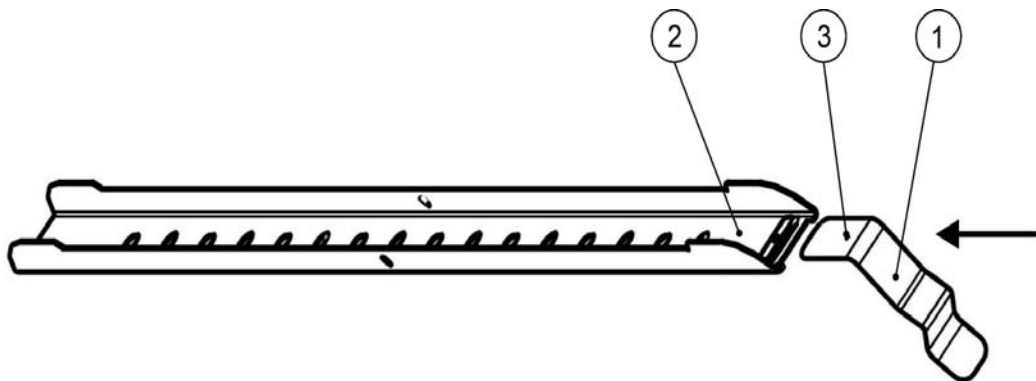
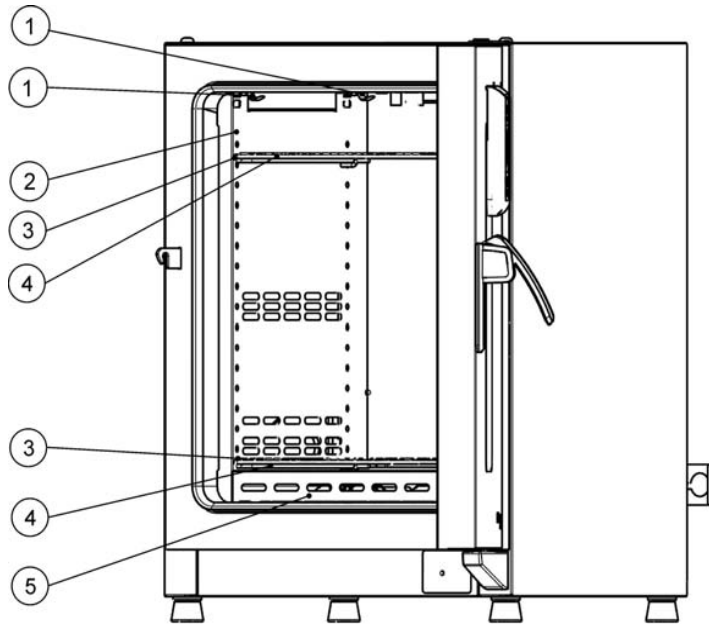

Figure 5-1 Sliding the Retaining Spring into the Support Rail

Installing the Shelving

The illustrations below show the placement of the shelf system elements.



- [1] Retaining spring
- [2] Air baffle, lateral
- [3] Shelf support
- [4] Wire-mesh shelf
- [5] Air baffle, bottom

Figure 5-2 OGH and OGH-S Series - Installing the Shelving

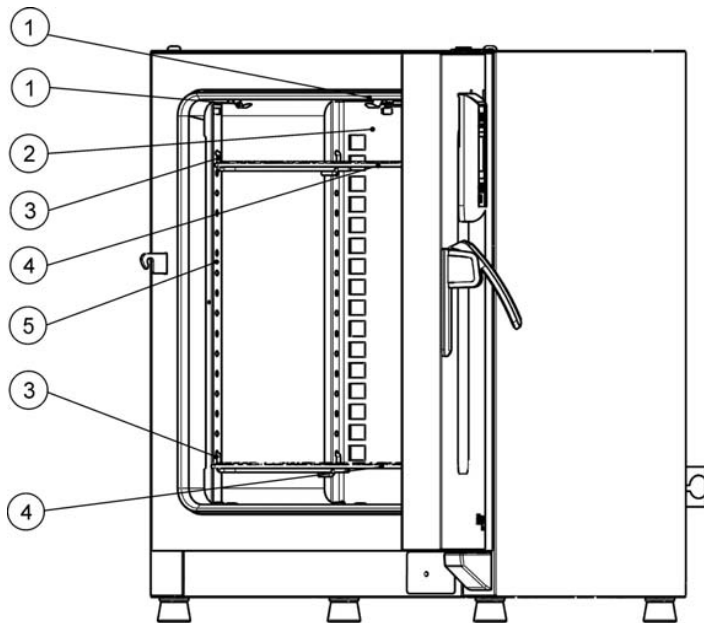

- [1] Retaining spring
- [2] Air baffle, rear
- [3] Shelf support
- [4] Wire-mesh shelf
- [5] Support rail

Figure 5-3 OMH and OMH-S Series - Installing the Shelving

Preparing the Work Space

The following work space components should be checked for cleanliness and cleaned prior to use:

- support rails,
- shelf support
- wire-mesh shelves,
- work space surfaces,
- work space seals and gaskets,

NOTE	Cleaning and disinfection For details about the cleaning of the oven, please refer to the section “Cleaning and Disinfection” on page 9-1 .
-------------	---

Table-top units

Installation or Removal of the Support Rails (OMH Series and OMH-S Series only)

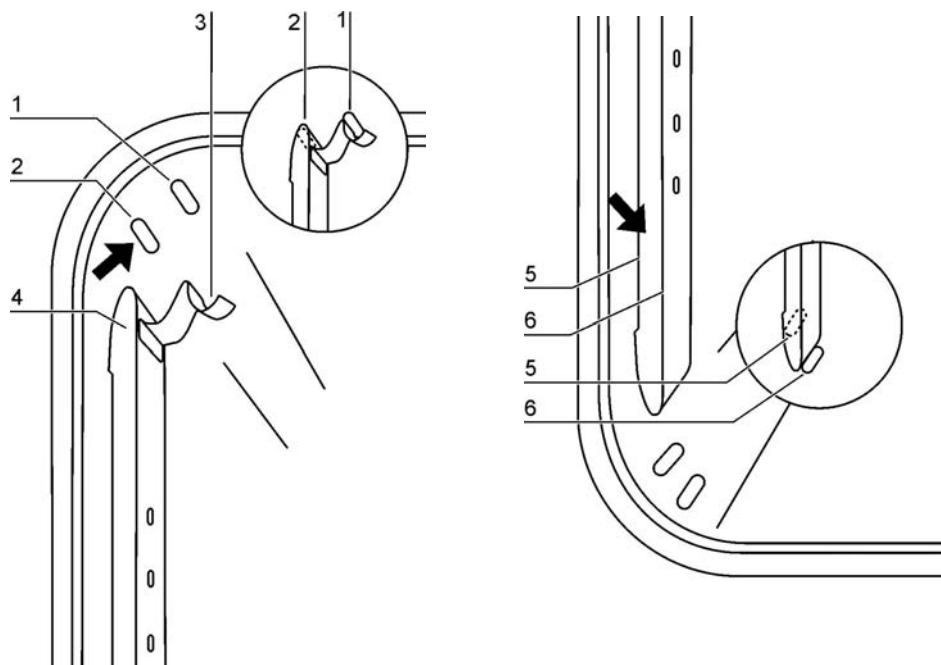

Figure 5-4 Support Rail Installation

The embossings at [2] and [7] act as lateral guides for the support rails, while the embossings at [1] and [6] secure the support rails in place. For the support rails to install correctly the retaining spring [3] must be facing upwards.

1. Place the support rail [4] on the lower embossing [6] and tilt it upwards against the work space side wall so that the rail is positioned over the two embossings at [5] and [2].
2. Clamp the retaining spring [3] behind the upper embossing [1].
3. To remove the support rails, pull the retaining spring tab down out of the embossing and remove the support rail assembly.

Installing and Uninstalling the Rear Air Baffle (OMH Series and OMH-S Series only)

Heratherm OMH Series and OMH-S Series ovens are shipped from the factory with an air baffle readily pre-installed at the back wall of the work space (while OGH Series and OGH-S Series ovens do not have this feature). Before the air baffle can be removed from the back wall, the support rails need to be uninstalled as explained further above.

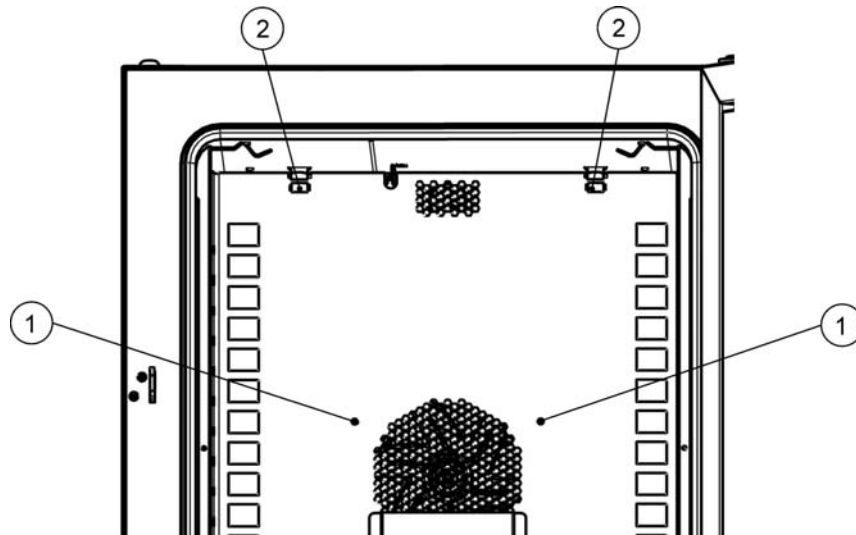



Figure 5-5 Installing the Rear Air Baffle

1. Loosen the two screws [1] that hold the air baffle to the back wall of the work space.

	WARNING	Risk of damage to sensor!
To prevent accidental damage, be sure to avoid collision with the sensor when installing or uninstalling panels in the oven's workspace.		

2. Grab the two retaining springs [2] at their tabs and pull them downwards out of the embossings, then pull off the rear air baffle.
3. For the rear air baffle to install correctly, the two retaining springs [2] must be facing upwards. Place the air baffle on the lower embossings and tilt it upwards against the back wall of the work space.
4. Clamp the two retaining springs [2] into the upper embossings.

5. Secure the air baffle to the work space back wall by fastening the two screws at [1].

Installing and Uninstalling the Lateral Air Baffles (OGH Series and OGH-S Series only)

The following section describes the installation and removal of the lateral air baffles.

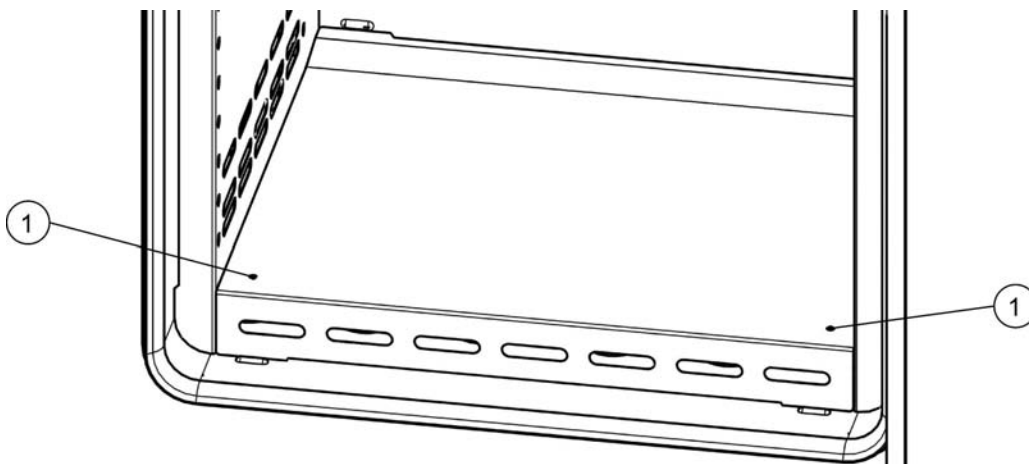

Figure 5-6 Removing the Bottom Panel

1. Loosen the two screws [1] in the bottom panel, then remove the entire bottom panel by lifting it out of its two embossings.

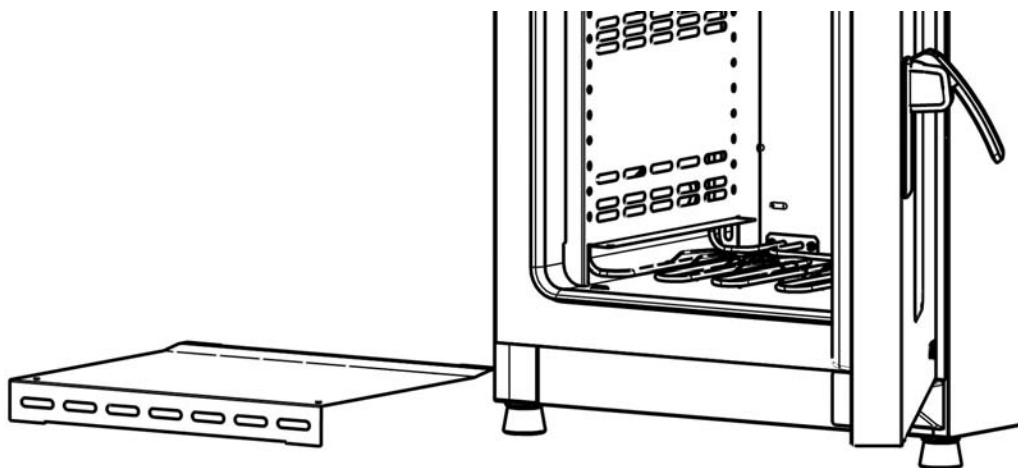



Figure 5-7 Bottom Panel Removed

2. Grab the two retaining springs [1] at their tabs and pull them downwards out of the embossings, then pull off the lateral air baffle.

	WARNING	Risk of damage to sensor!
To prevent accidental damage, be sure to avoid collision with the sensor when installing or uninstalling panels in the oven's workspace.		

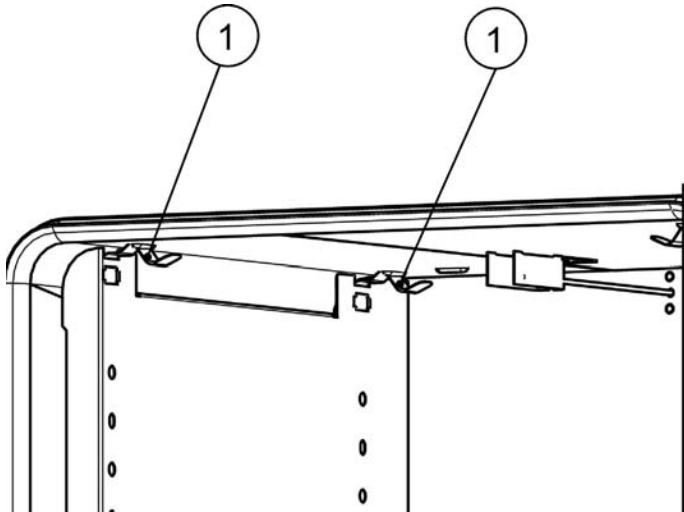

Figure 5-8 Removing the Lateral Air Baffle

3. For the lateral air baffles to install correctly, the two retaining springs [1] must be facing upwards. Place the lateral air baffle on the lower embossings and tilt it upwards against the side wall of the work space.
4. Clamp the two retaining springs [1] into the upper embossings.
5. Replace the bottom panel into the embossings and secure it by fastening the two screws at [1].

Levelling the Oven

1. Position a bubble level onto the center shelf.
2. Manually adjust the levelling feet until the wire-mesh shelf is horizontally aligned in all directions. Perform the adjustment of the levelling feet from left to right and from rear to front.

Commissioning of floor-mounted units

Installing/Removing air baffles (OMH Series)

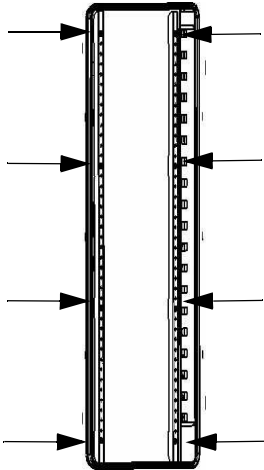

Figure 5-9 Removing the left and right support profiles

Loosen and remove the eight (8) screws for the left and right support profiles and then take out the lateral air baffles.

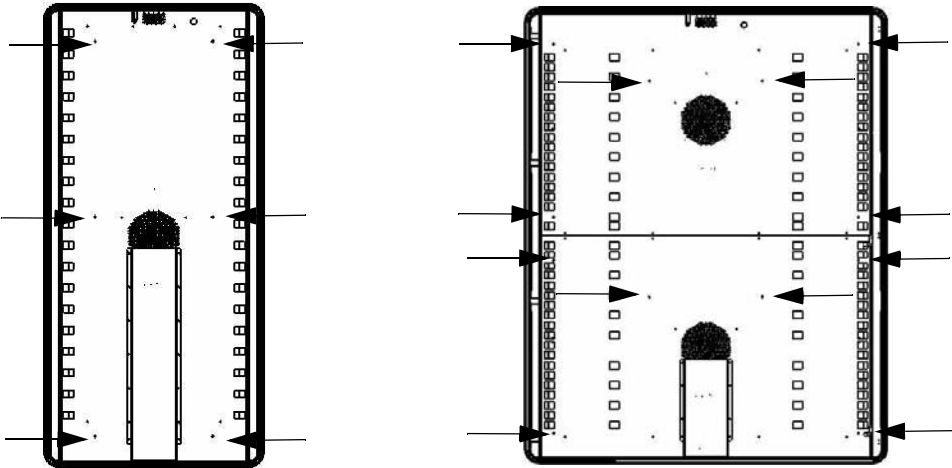

Figure 5-10 Removing the rear air baffle OMH 400/750

On the OMH 400 model loosen and remove the six (6) screws for the rear air baffle and for model OMH 750 loosen and remove the six (6) screws for the top and bottom rear air baffles and then remove the air baffle(s).

Commissioning, general

Installing the Shelf Support Brackets

1. Insert the shelf support brackets [3] into the perforations [1] of the support rail and air baffle and tilt them downwards.

NOTE	Horizontal position of support rails Please note the alternating sequence of round and oblong holes. Be sure to use the correct pair of opposite holes, so the support rails are truly horizontal.
-------------	---

2. Make sure that the two vertical elements [2] of the shelf support bracket butt against the support rail and air baffle.

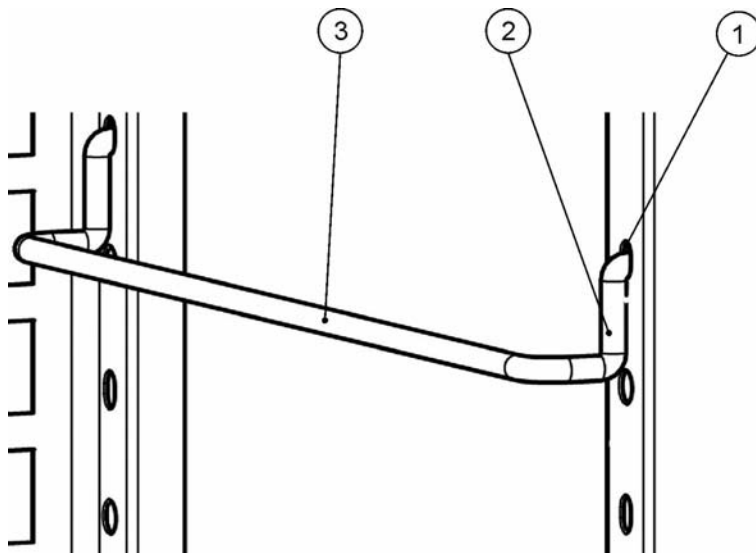

Figure 5-11 Shelf Support Bracket Installation

Installing the Wire-mesh Shelves

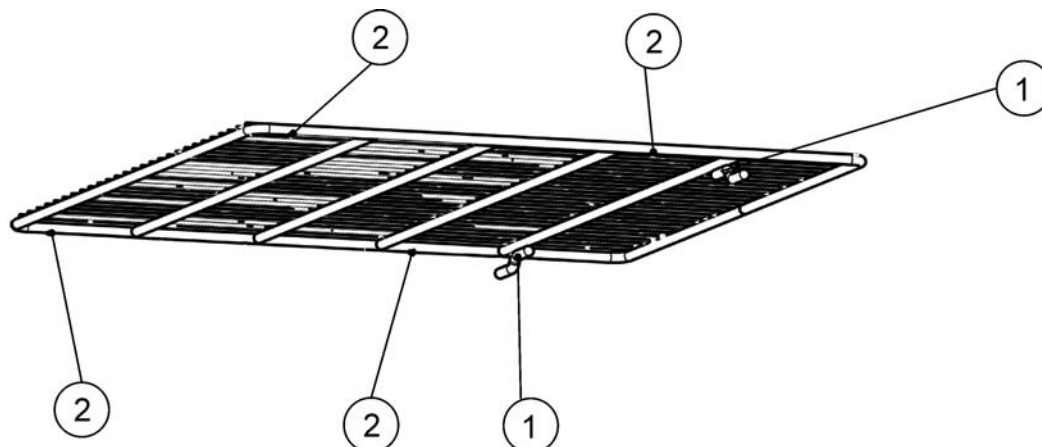



Figure 5-12 Wire-mesh shelf

1. Push the wire-mesh shelf onto the shelf support brackets with the tilt protection devices [1] facing the rear panel of the oven. The tilt protection devices [1] also serve as guides for the wire-mesh shelves.
2. Slightly raise the wire-mesh shelf so that the pull-out stops [2] can slide over the shelf support brackets.
3. Make sure that the shelves and both of their tilt protection devices are free to move over the shelf support brackets.

Connecting Power

	 DANGER	Electric shock
<p>Contact with live electrical components may cause a lethal electric shock. Before connecting the oven to the power supply, check the power cord and the plug for damage. Do not use damaged cables for connecting the oven to the power supply!</p>		

The oven has a class I, protection-earthed enclosure. To minimize the risk of electrical shock, use the AC power cord supplied to connect the oven to a correctly installed and protection-earthed power supply source, with the following features in place for each oven:

- T 16 A slow-blow fusing
- B 16 circuit breaker

	<div style="background-color: #0056b3; color: white; padding: 5px; display: inline-block;">NOTE</div> <p>Benefits of using separate electrical feeders</p> <p>Although several devices may be operated on the same electrical feeder if the rated current is not exceeded, we strongly recommended to provide one feeder with a dedicated upstream circuit breaker per oven to avoid the failure of multiple devices in case of an electrical fault.</p>
--	--

Connection to the Power Supply Source

1. Before connecting the oven to the power source, check to see if the power supply voltage corresponds with the specifications on the nameplate on the front of the oven. If the voltage (V) and current (A) ratings given are not as required, do not connect the oven to the power source!
2. Make sure the alarm contact remains disconnected at this time. If connected, disconnect it now to avoid a false alarm on the receiving end. You will get back to the alarm contact later on as you work your way through this start-up procedure.
3. Connect the IEC connector to the socket at the rear of the oven.
4. Route the power cord along a path that does not cross exhaust air piping or passageways and aisles. With stacked devices, keep the power cord away from hot spots on the other oven in the stack.
5. Connect the protection-earthed plug of the power cord to a correctly protection-earthed and earth leakage circuit breaker fused power socket.
6. Make sure the power cord is not subjected to tensile or compressive force.

	<div style="background-color: #0056b3; color: white; padding: 5px; display: inline-block;">NOTE</div> <p>Make sure that power outlets remain freely accessible at all times!</p> <p>In an emergency the power connection must be rapidly disconnectable; so be sure to have the power outlets freely accessible at all times!</p>
--	---

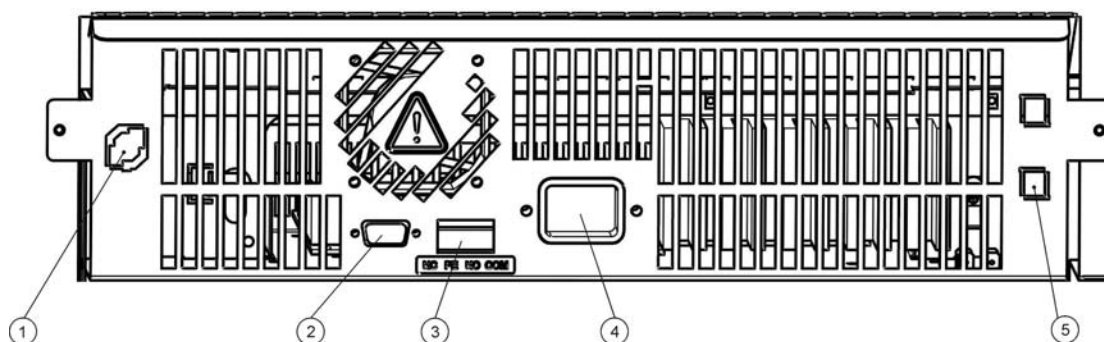

- [1] Sample /ECO Sensor
- [2] RS 232 interface
- [3] Alarm contact
- [4] IEC power socket

[5] 5 A fuse (with option “Viewing Windows with Workspace Lighting”, only)

Figure 5-13 AC Power Supply Socket

	NOTE	Condensation
		When taking the oven into operation for the first time allow some time for stabilization before switching on to avoid condensation forming on live parts.

Connecting the RS-232 Interface

	NOTE	
		Replacement should only be carried out by skilled and authorized qualified personnel of electrotechnology/signal engineering!

The RS-232 data communication interface supports the querying of status information and temperature data from the oven by entering basic commands in a standard terminal window provided by your computer's operating system. The interconnection requires a standard RS-232 cable with 9-pin connectors and a straight “1:1” pinout without any crossed wires, which is not supplied with the oven.

Interconnecting the Oven with a Computer

1. Turn the computer off.
2. Route the serial interface cable along a path that does not cross hot exhaust air piping, tables, aisles or passageways. With stacked devices, keep the serial interface cable away from hot spots on the other oven in the stack.
3. Connect one connector of the serial interface cable (cable length, 5 to max. 10 m, not supplied as a standard item) to the socket labeled **RS 232** in the electrical interfaces section at the rear of the oven (see “[RS 232 interface](#)” on [page 4-17](#)).
4. Connect the second connector to an unused COM 1 /COM 2 or other serial port on the computer.
5. Boot the computer.
6. Launch your standard terminal program and set up the connection with the following parameters:
 - 57600 bits per second
 - 8 data bits
 - 1 stop bit

— No Parity

- Once your terminal indicates that serial communication has been established successfully, enter any of the commands listed in [table 5-1](#) below, depending on what type of information you want to query.

		<p>Command Syntax Rules</p> <p>Be sure to enter the commands exactly as shown in the examples in table 5-1 below. Unsupported parameter addresses may lead to serious hardware malfunctions or damage the device, while unknown characters will result in error messages.</p>
--	---	---

- Use the following generic command syntax:

?:aaaa:bb::cc<CR>, where:

- **?:** identifies the command line as a query;
- **aaaa:** is the parameter address;
- **bb::** is a query, that must be left at „00” for technical reasons;
- **cc** is for a command - specific checksum listed in the table below.
- **<CR>** is for carriage return.

You will receive a response of the following general format:

!:aaaa:bb:XXXXX:cc<CR>, where:

- **!:** identifies the line as a response to a query;
- **aaaa:** is the parameter address entered with the query;
- **bb:** is the number of payload bytes in hexadecimal code - for example, **1F** for the decimal value **31**;
- **XXXXXX:** is the significant status information queried;
- **cc:** is a check sum (technically an inverted XOR of all bytes returned, excluding the check sum bytes and the **<CR>** character);
- **<CR>** is for carriage return.

Table 5-1 Terminal Commands for Querying Data

Command Syntax	Response Example
Combined Date and Time	
?:0010:00::c1	!:0010:11:31.07.10;01:02:23:e2 Date Time
Date only	

Table 5-1 Terminal Commands for Querying Data

Command Syntax	Response Example
?:0011:00::c0	!:0011:08:31.07.10:d2 Date
Time only	
?:0012:00::c3	!:0012:08:01:02:23:dc Time
Temperature Set Value (T1); Current Work Space Temperature (T2); Reference Temperature (T3); Sample Sensor Temperature (T4)	
?:3010:00::c2	!:3010:1f:+125.00;+124.96;+000.000;+000.00:b0 T1 T2 T3 T4

Wiring the Alarm Contact

	<p>NOTE Skilled work</p> <p>Thermo Electron LED GmbH warrants the operational safety and the operativeness of the oven only if installation and repairs are performed by skilled personnel.</p> <p>The connection of the oven to an external alarm system must only be carried out by adequately trained and authorized electrical engineering or telecommunications expert personnel!</p>
--	--

Functional Description

When system errors and failures occur in the temperature control circuits, an alarm message is issued to the connected alarm monitoring system. The potential-free contact (single changeover-type contact) has been designed for the circuit configuration specified below.

	<p>NOTE Switching behavior</p> <p>The alarm relay is energized by all error conditions reported by internal control loops.</p>
--	--

Alarm Relay Specifications

Circuit	Voltage	External fusing
Circuits with system voltage	max. 250 V ~	max. 6 A
SELV circuits (cf. VDE 0100, Part 410)	25 V ~	max. 2 A
	60 V =	max. 1 A
SELV-E circuits (cf. VDE 0100, Part 410)	50 V ~	max. 1 A
	120 V =	max. 0.5 A



CAUTION Alarm contact electrical compatibility considerations

To avoid overloading and damaging the alarm contact, check the electrical interfacing parameters of the alarm-receiving system for compatibility with the alarm relay specifications given above.

Connection Example

The connector [5] for the interface cable is supplied with the oven as a standard item. Specifications for the operating voltage and the fusing of external alarm circuitry are given in the table on the previous page.

1. Wire the individual conductors [1] through [4] of the interface cable as shown in the wiring diagram.
2. Route the alarm cable along a path that does not cross hot exhaust air piping, tables, aisles or passageways. With stacked devices, keep the serial interface cable away from hot spots on the other oven in the stack.
3. Plug the alarm system interface cable connector into the interface port [5] in the rear panel of the oven.

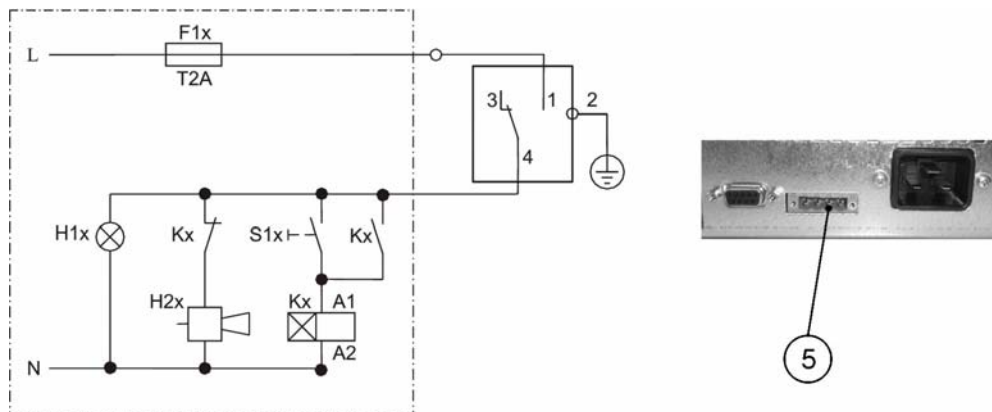

Alarm Relay Connection Example

The circuit diagram shown above represents the undisturbed condition of operation. In case of an error condition - including a power outage - contact closure occurs on the path between contacts 1-4.

**Start-up
Wiring the Alarm Contact**

Operation

Preparing the Oven

The oven must not be released for operation before all major start-up activities have been completed (see “Start-up” on [page 5-1](#)).



Device Check

Prior to starting operation, the following oven components must be checked for their correct function:

- The door seal in the front frame must not be damaged.
- The shelving components must be installed safely.

Starting Operation

1. Turn the oven on using the control panel.
2. Adjust the temperature set value on the control panel.
3. The temperature controller starts adjusting the work space to the user-specified temperature set value now.

		To avoid any risk of explosion or fire
<ul style="list-style-type: none">• refrain from loading the oven with any of the substances listed in the section “Incorrect Use” on page 1-5• make sure that the ambient air is free of any solvents• do not operate the oven in areas with an explosion hazard		

4. Load the work space with samples.



WARNING

Hot surfaces

After opening the door, this may swing back automatically.

The interior panel of the outer door as well as the surfaces of the outer housing, the shelving and the work space become extremely hot while the oven runs through its heating cycles.

When removing samples from a running or recently completed heating cycle, always wear safety gloves and other appropriate personal protection equipment to avoid burns on hot surfaces!



CAUTION

Risk of overloading

Overloading may damage the wire-mesh shelves or cause the shelves and/or the oven to tilt when the shelves are being drawn out, ultimately destroying the samples. To avoid overloading the oven or its wire-mesh shelving be sure to observe the sample weight limits specified in section “[Technical Data](#)” on [page 13-1](#).

NOTE

Proper loading

To ensure sufficient air circulation and uniform heating of the samples, do not use more than 70% of the maximum surface area of the work space. Bulky objects in the work space that dissipate heat may impair heat distribution.

Handling and Control

Heratherm OGH Series, OMH Series, OGH-S Series and OMH-S Series ovens come with a front panel mounted control unit consisting of a multifunctional display, four control buttons, and an on/off button. The four control buttons interact with the display window to let users access all of the user control functions and adjustments of the oven, including - for example, the temperature set value, timer, as well as a variety of other functions.

Under normal operating conditions the display presents user with the work space temperature. The display returns to its default mode upon completion of the adjustments or whenever no entries have been made for a period of 30 seconds.



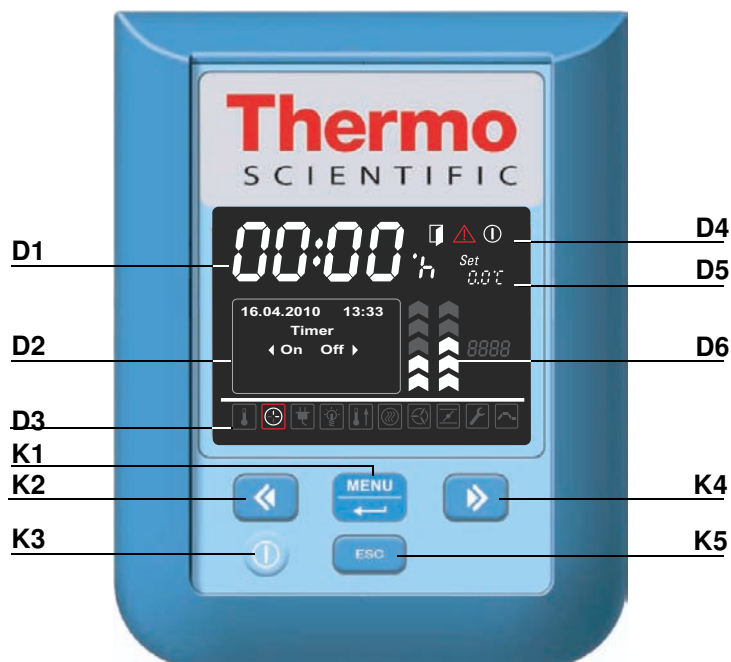

The graphic below shows the Heratherm OGH 60/100/180, Heratherm OMH 60/100/180/400/750, Heratherm OGH 60/100/180-S, and Heratherm OMH 60/100/180-S control panel with all of its visualization elements and controls.

Figure 7-1 Control Panel for Heratherm OGH Series, OMH Series, OGH-S Series and OMH-S Series Ovens



The table below contains brief descriptions of the buttons on the control panel (items K2 through K5 in [figure 7-1](#)).

Table 7-1 Control Buttons

Icon	Item	Function
	K1	<p>Menu/Enter button</p> <p>First key press: Activates the menu, highlighting the first menu item with a red border.</p> <p>Second key press: Selects the currently activated menu item (as highlighted by the red border), depending on the currently selected function, pressing this button enables entries with item D2, D5 or D6.</p> <p>Third key press (once a setting has been changed): Confirms a previous entry or selection.</p>
	K2	<p>Left button</p> <p>After the first press of Menu/Enter button:</p> <ul style="list-style-type: none"> - Moves the selection in the menu (see item D3) to the next icon on the left. <p>Once a menu item has been selected:</p> <ul style="list-style-type: none"> - Decreases an adjustable parameter value - for example, the temperature set value in D5 or the fan speed level at D6. Holding this button depressed for a few seconds changes the selected value in quick run mode. - Moves the selection in the multifunctional display pane at D2 to the next option on the left - for example, from the Off state of the timer to On.
	K3	<p>On/Off button</p> <p>Holding this button depressed for 2 seconds switches the oven off. The display window goes out, except for the readiness indicator icon in the status display area at item D4. The temperature display pane D1 provides as dimmed readout of the work space temperature, provided that the temperature exceeds 50 °C (122 °F).</p>
	K4	<p>Right button</p> <p>After the first press of Menu/Enter button:</p> <ul style="list-style-type: none"> - Moves the selection in the menu (see item D3) to the next icon on the right. <p>Once a menu item has been selected:</p> <ul style="list-style-type: none"> - Increases an adjustable parameter value - for example, the temperature set value in D5 or the fan speed level at D6. Holding this button depressed for a few seconds changes the selected value in quick run mode. - Moves the selection in the multifunctional display pane at D2 to the next option on the right - for example, from the On state of the timer to Off.
	K5	<p>Escape button</p> <p>Returns to the previous level of the menu or standard display. Upon exiting from the current menu item the user may be prompted to save any previously made settings.</p>

The table below contains brief descriptions of the display features of the control panel (items D1 through D6 in [figure 7-1](#); the identifiers K1 through K4 refer to the buttons shown in that figure).

Table 7-2 Display Features







Feature	Item	Function
	D1	Display pane showing a permanent readout of the actual temperature in the work space either in °C or °F (depending on the user's preferences, see "Temperature Display Unit" on page 7-34). Alternatively, a flashing time entry prompt of the general format hh:mm (hours:minutes, both with two digits) appears in this place while the user is setting the oven's built-in clock.
	D2	Four-line multifunctional display pane with fields for date and time, a display area for the specific options of the selected menu item, detailed alarm messages with alarm codes, progress indicators for continuous processes (for example, program-controlled temperature ramping), etc.
	D3	Menu bar with iconized representations of adjustable parameters. A red border is used to highlight the current Menü item, as selected using the Menu (K1) and arrow buttons Left (K2) and Right (K4). Brief descriptions of the individual menu items are given in table 7-3. Note If a menu item cannot be selected, then the function it represents is not part of the equipment configuration of your unit.
	D4	Status display area with three icons representing specific statuses of the oven (from left to right): - The Door open icon appears when the front door of the oven is open or has not been closed correctly (see "Door switch" on page 4-15). Note The Door open icon is only functional with OGH-S Series, OMH-S Series devices and OMH Floor stand units. - Upon occurrence of an error condition, the red alarm icon will be illuminated. At the same time the current error code will flash in the display pane D2. The alarm may be acknowledged by pressing the button  . - The readiness indicator icon appears when the oven has been switched off using the On/Off button (item K3 in figure 7-1).
	D5	Settings pane labeled Set for temperature set value in either °C or °F (depending on the user's preferences; see "Temperature Display Unit" on page 7-34).
	D6	The left one of the two vertical bar graphs belongs to the Fan icon directly beneath it and displays the current fan speed level. Bar graph for fan speed setting (in 5 steps: 1 – 5) - 20% (chevron 1 illuminated) - 40% (chevrons 1 and 2 illuminated) - 60% (chevrons 1 through 3 illuminated) - 80% (chevrons 1 through 4 illuminated) - 100% (chevrons 1 through 5 illuminated)

Table 7-2 Display Features

Feature	Item	Function
	D6	<p>The right one of the two vertical bar graphs belongs to the Damper icon directly beneath it and displays the current damper position.</p> <p>Bar graph for damper position (in 4 steps: 0 – 3)</p> <ul style="list-style-type: none"> - position 0 (damper closed - all chevrons extinguished) - position 1 (chevrons 1 and 2 illuminated) - position 2 (chevrons 1 through 4 illuminated) - position 3 (damper fully opened; chevrons 1 through 5 illuminated)

The table below contains brief descriptions of the menu bar icons (position D3 in [figure 7-1](#))

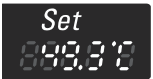
Table 7-3 Menu Bar Icons







Icon	Function
	<p>Temperature Set Value</p> <p>Allows for changing the temperature set value within the permissible temperature range. The set value can be changed by pressing the Left and Right (item K2 or K4) and you can, after confirming your changes with the Menu/Enter button (item K1), track the impact on the actual temperature in the multifunctional display pane at D1.</p> <p>Instructions: “Temperature Set Value” on page 7-7.</p>
	<p>Timer</p> <p>Allows for having the oven turn on or off upon expiry of a user-specified countdown period or at a fixed on or off time, or having it operate on a complete weekly schedule of daily on and off times. When the user enables an “on timer” the oven is turned off. A rotating arrow in the Timer icon and the illuminated readiness indicator icon in the status display area indicate that the timer is running.</p> <p>Instructions: “Timer” on page 7-9.</p>
	<p>Booster (only for Table-top units)</p> <p>A convenience feature designed to allow for speed-heating a cold and empty unit spontaneously (requires a set temperature of at least 150 °C/302 °F).</p> <p>Instructions: “Boost” on page 7-18.</p>
	<p>Fan</p> <p>Turns the fan on and allows for choosing the fan speed levels described under D6. The current setting is shown by the bar graph located directly above the icon and spelled out as a numeric value in the display pane at D2.</p> <p>Instructions: “Fan” on page 7-20.</p>
	<p>Damper</p> <p>Opens and closes the damper in graded steps. The current damper position is shown by the bar graph located directly above the icon and spelled out as a percentage in the display pane at D2.</p> <p>Instructions: “Damper” on page 7-24.</p>

Table 7-3 Menu Bar Icons

Icon	Function
	<p>Settings Invokes a submenu with the following functions:</p> <ul style="list-style-type: none"> - Read access to error log - Calibrating the oven - Setting date and time - Toggling the temperature display unit between °C and °F - Setting preferences for user programs (program cycles / mode after end) - Selecting the timer mode of operation (countdown / fixed time of day / weekday timer) - Entering a configuration control code <p>(Instructions: “Settings” on page 7-26)</p>
	<p>Program (Instructions: “Programming” on page 7-40) Allows for launching, creating, deleting, copying, and editing user programs.</p>

	<div style="border: 1px solid black; padding: 5px; display: flex; align-items: center;"> <div style="background-color: #0070C0; color: white; padding: 5px 10px; font-weight: bold; font-size: 1.2em; margin-right: 10px;">NOTE</div> <div> <p>Button Inactivity Monitoring</p> <p>When no button is pressed for more than 30 seconds in any selected menu item, the display exits from the selected screen and returns to default display mode.</p> </div> </div>
--	--

Powering Up

1. Plug the power plug of the oven into a suitable protection-earthed AC power outlet.



In the display window on the front panel the readiness indicator icon (rightmost icon in the status display area at D4 in [figure 7-1](#) on [page 7-1](#)) is illuminated.



2. Keep the **On/Off** button depressed for two seconds.

An initialization routine will be run after the oven has been powered up. Once initialization has been completed, the display will light up and the current work space temperature will appear in the temperature display pane (item D1 in [figure 7-1](#) on [page 7-1](#)). The oven is ready for use now.

Switching the Oven Off / Powering Down



1. Keep the **On/Off** button depressed for two seconds.



The display window goes out, except for the readiness indicator icon (rightmost icon in the status display area at D4 in [figure 7-1](#) on [page 7-1](#)) and a residual heat temperature readout in case the work space temperature is still ≥ 50 °C/122 °F. The oven is switched off now.

2. If required, unplug the AC power plug to power down the oven completely.



Temperature Set Value

Heratherm ovens allow for setting the desired work space temperature directly using only a few button presses. After confirming the new temperature set value in the settings pane **Set** (item D5 in [figure 7-1](#) on [page 7-1](#)), the user may trace the resulting temperature change in the temperature display pane (item D1 in [figure 7-1](#) on [page 7-1](#)).

You can also use the temperature set value to speed up cool-down subsequent to a drying or heating process. Temperatures as low as ambient +10 °C can be selected, this requires open damper and no additional heat in unit. You can set the oven to a set temperature of 0 °C (32 °F), though, to speed up cool-down. This is achieved in one single step, as described further below.









Table 7-4 Adjusting the Temperature Set Value

	<p>Press to activate the menu bar, then use to select the Temperature icon and press to confirm.</p>
	<p>In the flashing settings pane Set, press or to adjust a new temperature set value, then press to confirm your settings.</p>
	<p>The display returns to its default mode. The actual temperature measured in the work space and shown in the temperature display area starts to change until it reaches the newly adjusted set value.</p>

NOTE

Built-in heating and drying ovens Heratherm OGH, OGH-S, OMH und OMH-S are to be operated up to a working temperature of max. 250 °C (482 °F), only.

Table 7-5 Using the Temperature Set Value to Speed Up Cool-Down

	<p>At the end of the drying or heating process, press  to activate the menu bar, then use  to select the Temperature icon and press  to confirm.</p>
	<p>In the flashing settings pane <i>Set</i>, press  to lower the temperature set value to 50 °C (122 °F), then on  to 0 °C (32 °F) in one additional step. When the display reads 0 °C (32 °F), press  to confirm your settings.</p>
	<p>The display returns to its default mode. The actual temperature measured in the work space and shown in the temperature display area starts to drop, showing the progress of the cool-down process.</p>



Timer

The **Timer** feature from the menu bar enables the user to turn the oven on and off at scheduled times. The timer supports three different modes of operation, depending on the user's preferences:

- **Countdown-type on or off timer:** Turns the oven on or off after a user-specified period of time. Instructions on setting the preferences for this option are given in [table 7-6](#) below, while its use as an off timer and on timer are described in [table 7-7 on page 7-10](#) and [table 7-8 on page 7-10](#), respectively.
- **Fixed-time on or off timer:** Turns the oven on or off at a scheduled time. Instructions on setting the preferences for this option are given in [table 7-9](#), while its use as an off timer and on timer are described in [table 7-10 on page 7-11](#) and [table 7-11 on page 7-11](#), respectively.
- **Weekly timer:** Turns the oven on or off at scheduled times on specific days of the week. The process for setting the preferences for this option is described in [table 7-12](#), while instructions for programming the daily turn-on and turn-off times are given in [table 7-13 on page 7-12](#).

Programming a turn-on time causes the oven to shut down until it is scheduled to restart, while a turn-off time keeps it running before it shuts down at the user-specified time. The timer starts running immediately as soon as the user confirms his or her entries.

Pre-programmed routines (user programs, decontamination) override timer schedules. A timer will not start before a concurring program has finished execution.

Table 7-6 Presetting the Countdown Timer Mode of Operation

	<p>Press to activate the menu bar, then use to select the Settings icon and press to confirm.</p>
	<p>Press to switch to the Timer menu item and confirm the selection with .</p>
	<p>Press or to preselect the Countdown timer as the mode of your choice, then use to confirm the selection.</p>
	<p>The display returns to its default mode.</p>

Table 7-7 Setting a Countdown-type Off Timer















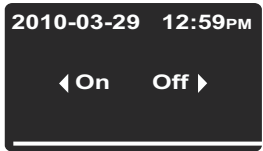

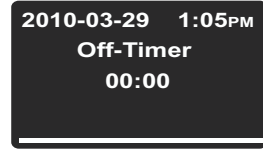



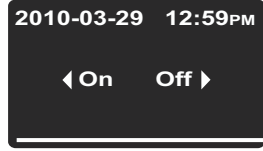

	<p>Press  to activate the menu bar, then use  to select the Timer icon and press  to confirm.</p>
	<p>Press  to select the off timer option Off.</p>
	<p>Set the hours and minutes until the oven is supposed to shut down by pressing  or , then press  to confirm.</p>
	<p>The display returns to its default mode. In the menu bar, the Timer icon is illuminated and an arrow is rotating on the icon's face.</p>

Table 7-8 Setting a Countdown-type On Timer

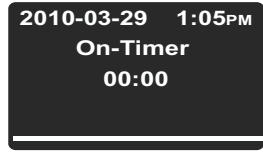
	<p>Press  to activate the menu bar, then use  to select the Timer icon and press  to confirm.</p>
	<p>Press  to select the on timer option On, then  to confirm.</p>
	<p>Set the hours and minutes until the oven is supposed to turn on by pressing  or , then press  to confirm.</p>
 	<p>The oven switches off. The display goes out, the Timer icon is illuminated in the menu bar with a hand rotating on its face. Additionally, the readiness indicator icon is illuminated.</p>

Setting a Fixed-time On or Off Timer

Table 7-9 Presetting the “Fixed-time” Timer Mode of Operation











	<p>Press  to activate the menu bar, then use  to select the Settings icon and press  to confirm.</p>
	<p>Press  to switch to the Timer menu item and confirm the selection with .</p>
	<p>Press  or  to preselect the Absolute fixed-time timer as the mode of your choice, then  to confirm the selection.</p>
	<p>The display returns to its default mode.</p>

Table 7-10 Setting a Fixed-time Off Timer



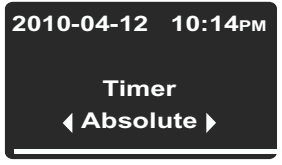







	<p>Press  to activate the menu bar, then use  to select the Timer icon and press  to confirm.</p>
	<p>Press  to select the off timer option Off.</p>
	<p>Set year, month, day, hours and minutes using  or , followed by  to confirm.</p>
	<p>In the menu bar, the Timer icon is illuminated and an arrow is rotating on the icon’s face.</p>

Table 7-11 Setting a Fixed-time On Timer

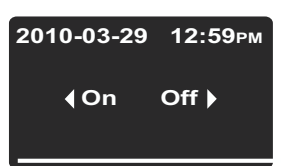

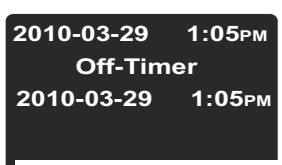







	<p>Press  to activate the menu bar, then use  to select the Timer icon and press  to confirm.</p>
	<p>Press  to select the on timer option On, then  to confirm.</p>

Table 7-11 Setting a Fixed-time On Timer

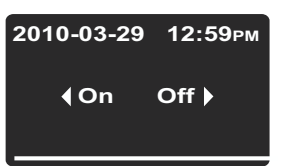
	<p>Set year, month, day, hours and minutes using  or , followed by  to confirm.</p>
	<p>The oven switches off. The display goes out, the Timer icon is illuminated in the menu bar with a hand rotating on its face. Additionally, the readiness indicator icon is illuminated.</p>

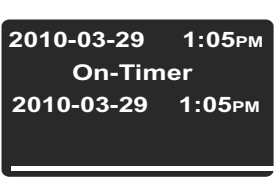
Setting a Weekly Timer

Table 7-12 Presetting the Weekly Timer Mode of Operation











	<p>Press  to activate the menu bar, then use  to select the Settings icon and press  to confirm.</p>
	<p>Press  to switch to the Timer menu item and confirm the selection with .</p>
	<p>Press  or  to preselect the Weekly timer as the mode of your choice, then  to confirm the selection.</p>
	<p>The display returns to its default mode.</p>

Table 7-13 Setting a Weekly Timer

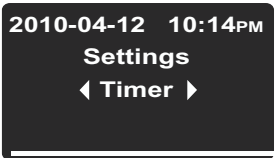

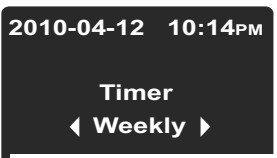











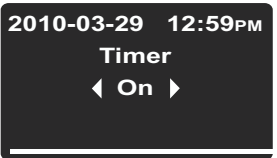



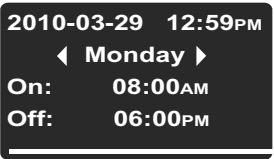







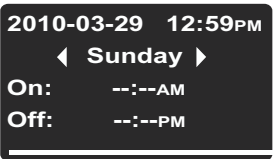

	<p>Press  to activate the menu bar, then use  to select the Timer icon and press  to confirm.</p>
	<p>In the selection screen shown at left, press  to switch from On to the Edit option.</p>
	<p>Select the Edit option by pressing .</p>

Table 7-13 Setting a Weekly Timer

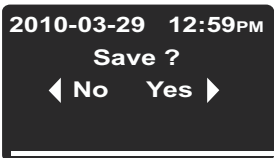
	<p>Press  to select the On time for Monday, which should start flashing when selected (or continue to the desired weekday by pressing , which will cause the on time of that day to start flashing;</p> <p>Press  or  to set the hours, then continue to minutes by pressing .</p> <p>Use  or  to set the minutes . Then continue to Tuesday or any other desired weekday by pressing .</p> <p>To prevent the oven from turning on and back off on a specific day, set both hours and minutes to --:--.</p>
	<p>Set the scheduled turn-on and turn-off times for each single day of the week all the way to Sunday and press . (The turn-on and turn-off times for Saturday and Sunday are disabled by default.)</p> <p>If there is no need to set or change the turn-on and/or turn-off times for a specific weekday, press  and  or  to go back and forth to the previous and next day, respectively.</p>
	<p>When prompted to save your changes, press  to confirm.</p> <p>Note This prompt for saving also appears when you press the button Esc while working on the weekly timer's settings.</p>
	<p>To enable the weekly timer press .</p> <p>Alternatively, press  and  to select the Off option if the weekly timer you have just saved should be activated at a later date.</p>
	<p>In the menu bar, the Timer icon is illuminated and an arrow is rotating on the icon's face.</p>

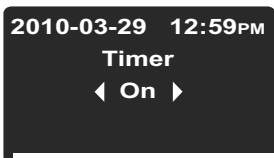
Stopping a Timer

Table 7-14 Stopping an Off Timer Before It Expires







	<p>Press  to activate the menu bar, then use  to select the Timer icon and press  to confirm.</p>
	<p>Press  to confirm the Yes default selection.</p>
	<p>In the menu bar, the Timer icon will go out. The display returns to its default mode.</p>

Table 7-15 Stopping an On Timer Before It Expires



	<p>To cancel a pre-programmed on timer while the oven is switched off, hold the On/Off button depressed for a few seconds.</p>
	<p>In the Stop Timer? prompt that appears, confirm the default selection Yes by pressing .</p>
	<p>In the menu bar, the Timer icon will go out. The display returns to its default mode.</p>

Table 7-16 Stopping a Weekly Timer Before It Expires









	<p>Press  to activate the menu bar, then use  to select the Timer icon and press  to confirm.</p>
	<p>The flashing word On appears in the multifunctional display pane.</p> <p>Press  to switch to Off state, then press .</p>

Table 7-16 Stopping a Weekly Timer Before It Expires

	The message Timer stopped! appears as a confirmation.
	In the menu bar, the Timer icon will go out. The display returns to its default mode.

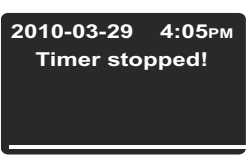

Light

This menu item toggles the interior light in the work space of the device on and off (requires optional inspection package - for table-top units). While the light is switched on the **Light** icon is illuminated in the menu bar.

Table 7-17 Turning the Light On

	<p>Press to activate the menu bar, then use to select the Light icon and press to confirm.</p>
	<p>In the selection screen that appears confirm the selection by pressing .</p>
	<p>The selected option On remains in the multifunctional display pane for a few seconds to let you track your action.</p>
	<p>The display returns to its default mode. The Light icon in the menu bar is illuminated to indicate that the light is on inside the oven.</p>

Table 7-18 Turning the light off

	<p>Press to activate the menu bar, then use to select the Light icon and press to confirm.</p>
	<p>In the selection screen that appears confirm the selection by pressing .</p>
	<p>The selected option Off remains in the multifunctional display pane for two seconds to let you track your action.</p>
	<p>The display returns to its default mode. The Light icon in the menu bar is extinguished to indicate that the light is off inside the oven.</p>

	<table border="1"><tr><td data-bbox="533 241 895 333">NOTE</td><td data-bbox="922 259 1220 293">Lighting Restrictions</td></tr><tr><td colspan="2" data-bbox="517 353 1445 454"><p>The workspace lighting is not designed for use as a permanent illumination source. Use it for brief visual checks of the device's interior only.</p></td></tr></table>	NOTE	Lighting Restrictions	<p>The workspace lighting is not designed for use as a permanent illumination source. Use it for brief visual checks of the device's interior only.</p>	
NOTE	Lighting Restrictions				
<p>The workspace lighting is not designed for use as a permanent illumination source. Use it for brief visual checks of the device's interior only.</p>					

	<table border="1"><tr><td data-bbox="533 521 895 613">NOTE</td><td data-bbox="922 539 1396 573">Maximum Operating Temperature</td></tr><tr><td colspan="2" data-bbox="517 633 1445 734"><p>The Viewing Package with viewing windows and workspace lighting limits the operating temperature range of the heating and drying oven to 250 °C (482 °F).</p></td></tr></table>	NOTE	Maximum Operating Temperature	<p>The Viewing Package with viewing windows and workspace lighting limits the operating temperature range of the heating and drying oven to 250 °C (482 °F).</p>	
NOTE	Maximum Operating Temperature				
<p>The Viewing Package with viewing windows and workspace lighting limits the operating temperature range of the heating and drying oven to 250 °C (482 °F).</p>					



Boost

The boost feature (only for table-top units) allows for speed-preheating a cold, empty oven to a previously adjusted temperature set value (see “Temperature Set Value” on page 7-7) of at least 150 °C (302 °F). In boost mode, the oven’s heaters work at their full capacity to approximate the set temperature as fast as possible. This feature may disable overheat protection for up to 30 minutes and allow the heater to work with temporary peak temperatures. Once the preset temperature has been reached, the unit is restored to normal temperature control, and the user may proceed to loading the oven with the samples.

	CAUTION	<p>Risk of damage to samples!</p> <p>Be sure to remove the material to be dried and all other temperature-sensitive items from the oven’s workspace before speed-heating the oven. High temperatures which could possibly damage the samples may temporarily prevail in the work space once the oven has been speed-heated using the boost feature.</p>
--	----------------	---

Table 7-19 Turning Boost On

	Set the temperature set value to at least 150 °C/302 °F (see “Temperature Set Value” on page 7-9).
	Press to activate the menu bar, then use to select the Boost icon and press to confirm.
	In the selection screen that appears, confirm the preselected option On by pressing .
	The selected option On remains in the multifunctional display pane for a few seconds to let you track your action.

Table 7-19 Turning Boost On













 	<p>The display returns to its default mode.</p> <p>The Boost icon in the menu bar is illuminated to indicate that boost mode has been activated.</p> <p>Once the preset temperature set value has been reached, the boost heater turns off automatically, and the Boost icon goes out.</p>
 	<p>Risk of burns! Depending on the chosen temperature set value, high temperatures may prevail in the work space once the oven has been speed-heated using the boost feature.</p> <p>To avoid the risk of injury, users must wear protective gloves or other suitable personal protection equipment when loading the work space of the oven!</p>

Table 7-20 Turning boost off prematurely

	<p>Press  to activate the menu bar, then use  to select the Boost icon and press  to confirm.</p>
	<p>In the selection screen that appears, confirm the preselected option Off by pressing .</p>
	<p>The selected option Off remains in the multifunctional display pane for a few seconds to let you track your action.</p>
	<p>The display returns to its default mode.</p> <p>The Boost icon in the menu bar is extinguished to indicate that boost mode has been turned off.</p>

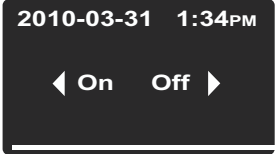

Fan

This menu item allows for turning on the fan in the work space and simultaneously gradually adjusting the speed of the fan. The current setting of the fan is indicated by the illuminated **Fan** icon in the menu bar and the five-level bar graph (see item D6 in [figure 7-1](#) on [page 7-1](#)) for the fan speed setting located directly above the icon.

Table-top units

The unit contains a regulated fan; fan speed can be lowered (adjusted) in 5 stages:

- 20% (1 chevron illuminated)
- 40% (2 chevrons illuminated)
- 60% (3 chevrons illuminated)
- 80% (4 chevrons illuminated)
- 100% (5 chevrons illuminated)

To protect the oven from overheating, however, the built-in controller may override the user's setting and increase the fan speed automatically when the work space temperature rises above the set value. A fan error will occur on a loss of speed.

Table 7-21 Turning on the Fan





	<p>Press  to activate the menu bar, then use  or  to select the Fan icon and press  to confirm.</p>
	<p>The settings dialog shown at the left appears in the multifunctional display pane now, with the value 20% flashing.</p>

Table 7-21 Turning on the Fan



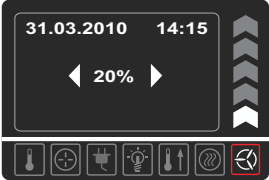

	<p>Keep this setting or press  as often as needed to accomplish the desired fan level, then press  to confirm.</p> <p>The multifunctional display pane will show the current fan speed level as a percentage (20%, 40%, 60%, 80% or 100%). Additionally, the matching number of chevrons will be illuminated in the bar graph to the right.</p>
	<p>The display returns to its default mode.</p> <p>The Fan icon in the menu bar is illuminated now to indicate that the fan is running.</p>

Table 7-22 Adjusting Fan Speed



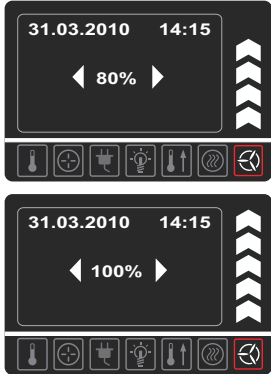







	<p>Press  to activate the menu bar, then use  or  to select the Fan icon and press  to confirm.</p>
	<p>The settings dialog shown at left appears in the multifunctional display pane now, with the current fan speed setting flashing already.</p>
	<p>Change fan speed with  or , then press  to confirm.</p>

Table 7-22 Adjusting Fan Speed

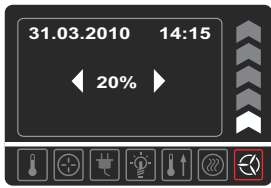
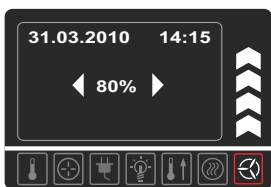
	<p>If the Heater prot. message appears when you try to turn off the fan or reduce its speed:</p> <p>OMH Series and OMH-S Series ovens employ forced ventilation, that is, the fan cannot be turned off completely and will run at a variable minimum speed when a certain temperature limit is exceeded. Any attempt to return the fan speed level to 0% will be denied, as indicated by the message heater prot in the multifunctional display pane.</p> <p>Likewise, the heater prot. message may appear upon the first press of the  button or any subsequent step when you try to reduce fan speed. This indicates that the overheat protection feature has taken over fan control, regulating fan speed automatically to a safe level that rules out any thermal damage to the oven's heating circuits.</p> <p>In either case, fan speed control is restricted to the speed level admitted by the controller or remains disabled altogether until the workspace temperature has returned to a safe level.</p>
	<p>The display returns to its default mode.</p> <p>The Fan icon remains illuminated in the menu bar.</p>

Floor mounted units

The unit contains a regulated fan; fan speed can be lowered (adjusted) in 2 stages:

Minimum fan speed (chevrons 1 through 3 illuminated)

Maximum fan speed (chevrons 1 through 5 illuminated)

Table 7-23 Turning on the Fan







	<p>Press  to activate the menu bar, then use  or  to select the Fan icon and press  to confirm.</p>
	<p>The settings dialog shown at left appears in the multifunctional display pane now, with the current fan speed setting flashing already.</p>

Table 7-23 Turning on the Fan















	<p>Press  as often as needed to accomplish the 2. fan level, then press  to confirm.</p> <p>The multifunctional display pane will show the current fan speed level as a percentage (60% or 100%). Additionally, the matching number of chevrons will be illuminated in the bar graph to the right.</p>
	<p>The display returns to its default mode.</p> <p>The Fan icon in the menu bar is illuminated now to indicate that the fan is running.</p>

Table 7-24 Adjusting the Fan (only table-top units)

	<p>Press  to activate the menu bar, then use  or  to select the Fan icon and press  to confirm.</p>
	<p>The settings dialog shown at left appears in the multifunctional display pane now, with the current fan speed setting flashing already.</p>
	<p>Change fan speed with  or , then press  to confirm.</p>
	<p>The display returns to its default mode.</p> <p>The fan continues to run until the unit is switched off.</p>



Damper

This menu item allows for gradually opening and closing the damper that vents the oven's work space. The current status of the damper will be indicated by illumination of the **Damper** icon in the menu bar and the four-level bar graph (see item D6 in [figure 7-1](#) on [page 7-1](#)) for the damper's angular position, located directly above the icon. The damper can be adjusted in 4 steps:

- Position **0**: damper closed - all chevrons extinguished
- Position **1**: chevrons 1 and 2 illuminated
- Position **2**: chevrons 1 through 4 illuminated
- Position **3**: damper fully opened; chevrons 1 through 5 illuminated

Table 7-25 Opening the Damper

















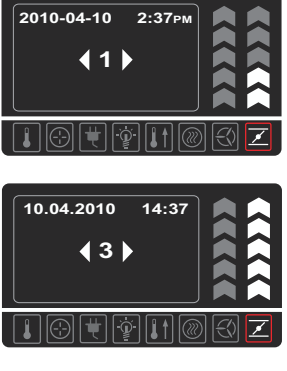







	<p>Press  to activate the menu bar, then use  or  to select the Damper icon and press  to confirm.</p>
	<p>The settings dialog shown at left appears in the multifunctional display pane, with the starting value 0 flashing.</p>
	<p>Press  as often as needed to accomplish the desired damper setting, then confirm with . The multifunctional display pane will show the current damper setting as a numerical value between 0 and 3. Additionally, the matching number of chevrons will be illuminated in the bar graph to the right.</p>
	<p>The display returns to its default mode. The Damper icon in the menu bar is illuminated now to indicate that the damper has been opened and how far.</p>

Table 7-26 Adjusting the Damper Position or Closing the Damper

	<p>Press  to activate the menu bar, then use  or  to select the Damper icon and press  to confirm.</p>
	<p>The settings dialog shown at left appears in the multifunctional display pane now, with the current damper position flashing already.</p>
	<p>Use  or  to change the damper position, then confirm with .</p>
	<p>To close, set the damper position to 0 using , then confirm with .</p>
	<p>The display returns to its default mode. If you have just readjusted the damper position, the Damper icon will remain illuminated in the menu bar. Should you have chosen to turn close the damper altogether, the Damper icon in the menu bar will be extinguished.</p>



Settings

The **Settings** menu item opens a submenu populated with various commands for viewing general status information on the unit and setting preferences for the operation of the oven or its display window:

- Read access to error log
- Calibrating the oven
- Setting date and time
- Toggling the temperature display unit between °C and °F
- Toggling process protection on and off
- Setting preferences for user programs (program cycles / mode after end)
- Selecting the timer mode of operation (countdown / fixed time of day / weekday timer)
- Entering a configuration control code

Instructions for using these features are given in the following.

Error Log





Users calling customer service for support may be asked by the agent to supply information from the error log of the oven. This internal memory may be accessed by choosing the **Settings** -> **Error** menu item. It enables the user to browse through the most recent 22 alarm messages that were caused by hardware or control loop errors. Each error is displayed with the date and time of its occurrence, a brief clear text description and an internal error code.

Error codes and instructions for clearing alarm conditions appear in the section “[Error Codes](#)” on [page 12-1](#).

Table 7-27 Reading the Error Log

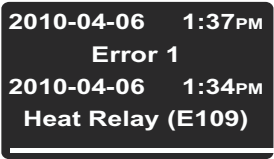
	<p>Press to activate the menu bar, then use or to select the Settings icon and press to confirm.</p>
	<p>Press to select the Error item from the Settings submenu.</p>
	<p>The first entry of the error log is displayed, numbered “0”. This entry represents the most recently registered error.</p>

Table 7-27 Reading the Error Log

	<p>Press  to go to the next entry (or ) to go back to the previous one). After the entry numbered 21 the display wraps and returns to the beginning of the error log, displaying entry “Error 0.”</p>
	<p>To exit from the error log and return to normal display mode press  . The Settings icon in the menu bar will go out.</p>

Calibration

The **Settings** -> **Calibration** menu item enables the user to initiate a temperature calibration routine (see “[Temperature Calibration Procedure](#)” on [page 10-3](#)) for the built-in temperature sensors and choose whether calibration should be accomplished manually or automatically:

- The **Manual** option allows for entering an absolute temperature directly, as measured - for example, using an external reference sensor.
- The Eco function (optional) is required for using the Eco convenience program. It computes the spatial temperature difference between the temperature prevailing at the location of the sample (as measured by the sample sensor; accessory part to be ordered separately) and the current workspace temperature (as measured by the built-in sensor of the oven). The built-in controller uses the result to compute a temperature limit that marks the end of the drying process. The temperature preset on the oven during the Eco calibration process must be equal to the ultimate temperature set value for the drying process. The Eco convenience program and its use are described in more detail in the section “[ECO Convenience Program \(only for table-top units\)](#)” on [page 7-40](#).
- The Sample function (optional) allows for a thermal calibration of a sample sensor (accessory to be ordered separately) connected to the oven by direct entry of an absolute value measured using an external temperature measuring device.

	<div style="border: 1px solid black; padding: 5px; margin-bottom: 10px;"> <p style="margin: 0;">NOTE</p> </div> <p>Calibration Prerequisites</p> <p>Maintain the ambient conditions within the specified limits of the oven and make sure that the damper is fully closed before launching calibration.</p> <p>Varying ambient conditions and/or an open damper may impact the result of the calibration routine, which may lead to misadjustment of the controller and unreliable temperature control operation.</p>
--	---

Table 7-28 Entering the Calibration Reference Temperature Manually











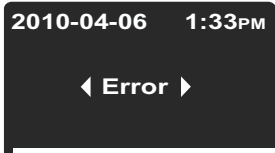
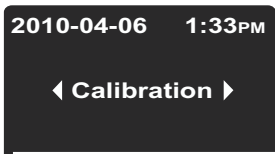

	<p>Press  to activate the menu bar, then use  or  to select the Settings icon and press  to confirm.</p>
	<p>The Error menu item from the Settings submenu appears in the multifunctional display pane.</p>
	<p>Press  to switch to the Calibration menu item and confirm the selection with .</p>
	<p>In the Calibration selection screen, press  to choose the preselected option Manual.</p>
	<p>In the settings dialog that appears, set the temperature measured with the external reference sensor by using  or  and confirm the settings with .</p>
	<p>The newly entered value will be stored and used to calibrate the internal temperature sensors with the value measured by the reference sensor. The display returns to its default mode. The Settings icon in the menu bar will go out.</p>

Table 7-29 ECO Temperature Calibration (only for table-top units)

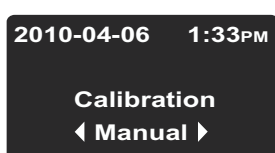

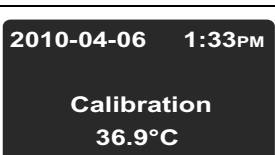

	<p>Place the temperature sensor at the location where the sample is to be placed. Route the sensor lead through the tube access port in the back wall of the oven and plug it into the connect on the device's back panel.</p>
	<p>Press  to activate the menu bar, then use  or  to select the Settings icon and press  to confirm.</p>

Table 7-29 ECO Temperature Calibration (only for table-top units)











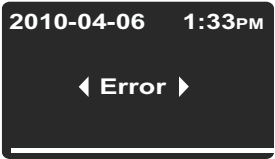
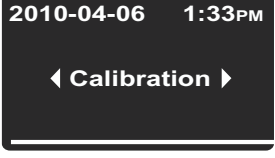

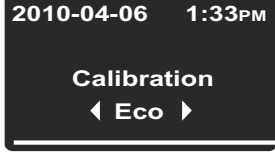

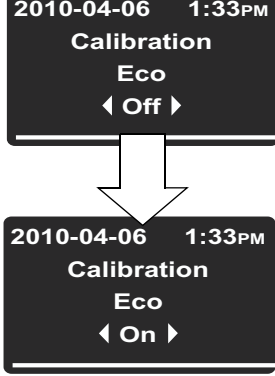

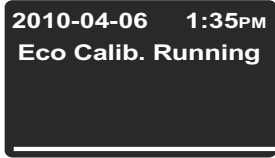

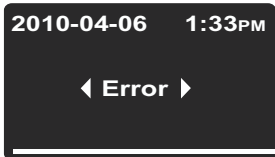
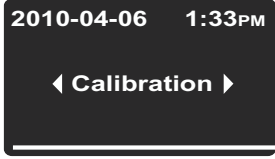

	<p>The Error menu item from the Settings submenu appears in the multifunctional display pane.</p>
	<p>Press  to switch to the Calibration menu item and confirm the selection with .</p>
	<p>In the Calibration selection screen, press  to choose the Eco option and confirm the selection with .</p>
	<p>The current operating status appears in the display pane, represented by the flashing word Off. Press  to switch to On state, then  to confirm. The selected option On remains in the display pane for a few seconds to let you track your action.</p>
	<p>The confirmation message Eco Calib. Running appears in the multifunctional display pane to indicate that automatic calibration is running.</p>
	<p>The Settings icon in the menu bar will go out. Once the calibration process has been accomplished, the display returns to its default mode.</p>

Table 7-30 Entering the Calibration Reference Temperature for the Sample Sensor Manually

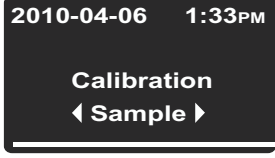
	Place the sample sensor at the location where the sample is to be placed. Route the sensor lead through the tube access port to an external temperature measuring device.
	Power up the measuring device and wait until the sample sensor has stabilized and provides a constant temperature reading.
	Press  to activate the menu bar, then use  or  to select the Settings icon and press  to confirm.
	The Error menu item from the Settings submenu appears in the multifunctional display pane.
	Press  to switch to the Calibration menu item and confirm the selection with  .
	In the Calibration selection screen, press  to choose the Sample option.
	In the settings dialog that appears, set the temperature measured with the external reference sensor by using  or  and confirm the settings with  .
	The newly entered value will be stored and used to calibrate the built-in controller to the absolute value measured by the sample sensor. The display returns to its default mode. The Settings icon in the menu bar will go out.

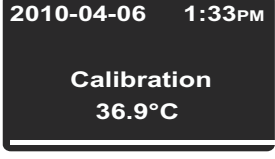
Date and Time

The **Settings** -> **Time / Date** option allows for switching between the international time and date display formats and for setting the time and date of the internal clock. There are two display formats to choose from:

- European date format *DD.MM.YYYY* and 24-hours time format. Example: *07.04.2010* and *15:05*.
- US standard date format *YYYY-MM-DD* and 12-hour time format with *AM/PM* suffix. Example: *2010-04-07* and *3:05 PM*.

Table 7-31 Setting the Date Format











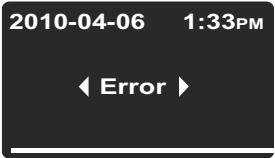
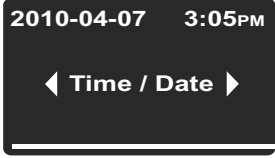

	<p>Press  to activate the menu bar, then use  or  to select the Settings icon and press  to confirm.</p>
	<p>The Error menu item from the Settings submenu appears in the multifunctional display pane.</p>
	<p>Press  to switch to the Time / Date menu item and confirm the selection with .</p>
	<p>The Date menu item is flashing in the multifunctional display pane.</p> <p>Choose the preselected option Date by pressing . The date field will start flashing in the upper left corner of the multifunctional display pane.</p>
	<p>Press  or  to switch to the desired date format DD.MM.YYYY or YYYY-MM-DD and confirm the selection with .</p> <p>The date field in the upper left corner will change its appearance according to your selection (and stop flashing).</p>
	<p>The display returns to its default mode.</p> <p>The Settings icon in the menu bar will go out.</p>

Table 7-32 Setting the Time Format

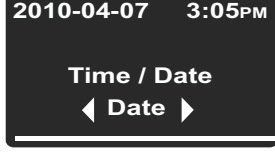

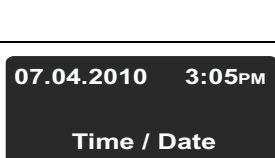











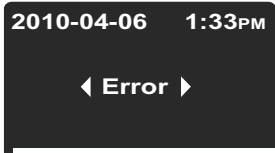
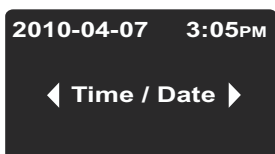

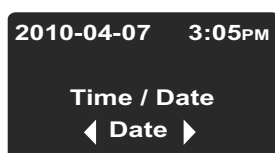
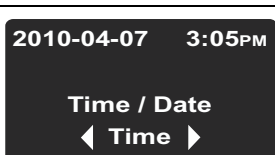











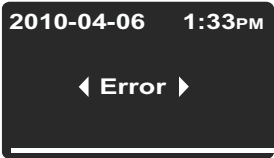
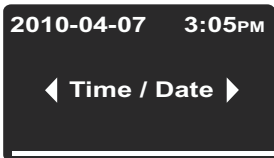

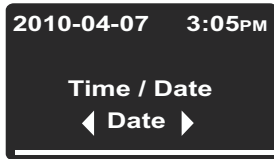
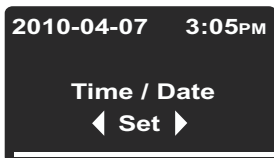
	<p>Press  to activate the menu bar, then use  or  to select the Settings icon and press  to confirm.</p>
	<p>The Error menu item from the Settings submenu appears in the multifunctional display pane.</p>
	<p>Press  to switch to the Time / Date menu item and confirm the selection with .</p>
	<p>The Date menu item is flashing in the multifunctional display pane.</p>
	<p>In the flashing Date menu item, press  to switch to the Time option and confirm the selection with . The Time menu item is flashing in the multifunctional display pane, along with the time field in the upper right corner.</p>
	<p>Press  or  to switch to the desired time format hh:mm or hh:mm AM/PM and confirm the selection with .</p> <p>The time field in the upper left corner will change its appearance according to your selection (and stop flashing).</p>
	<p>The display returns to its default mode. The Settings icon in the menu bar will go out.</p>

Table 7-33 Setting Date and Time









	<p>Press  to activate the menu bar, then use  or  to select the Settings icon and press  to confirm.</p>
	<p>The Error menu item from the Settings submenu appears in the multifunctional display pane.</p>
	<p>Press  to switch to the Time / Date menu item and confirm the selection with .</p>
	<p>The Date menu item is flashing in the multifunctional display pane.</p>
	<p>From the flashing Date menu item, press  to switch to the Set option and confirm the selection with . The Set menu item is flashing in the multifunctional display pane now, along with the year section of the date field in the upper left corner.</p>
	<p>Press  or  to set the year and confirm your settings with . The flashing selection moves on to the month section of the date field. Set months, days, hours and minutes using  or  and confirm each setting with .</p>
	<p>When you confirm with the button  after setting the minutes, the date and time field in the upper right corner will be updated according to your settings (and stop flashing). The display returns to its default mode. The Settings icon in the menu bar will go out.</p>

Temperature Display Unit

The **Settings** -> °C / °F menu item allows for toggling the unit used for displaying temperatures between degrees Centigrade and Fahrenheit.

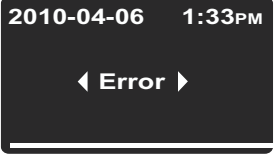
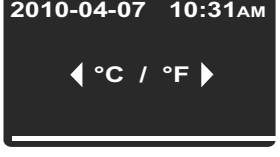
Note This setting does not have any impact on data logging via the RS-232 interface. Any temperature data that is logged to a computer for operational parameter documentation purposes is handed over in °C.

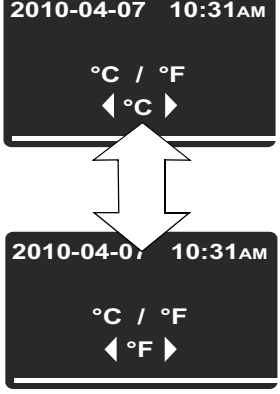



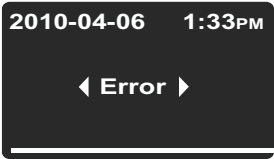
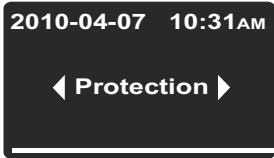

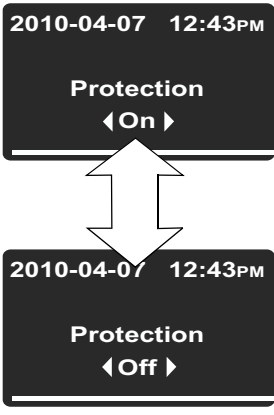



Table 7-34 Toggling the Temperature Display Unit

	<p>Press  to activate the menu bar, then use  or  to select the Settings icon and press  to confirm.</p>
	<p>The Error menu item from the Settings submenu appears in the multifunctional display pane.</p>
	<p>Press  to switch to the °C / °F menu item and confirm the selection with .</p>
	<p>The multifunctional display pane changes to the following selection screen, with the currently unused temperature display unit flashing (°C or °F) (The factory default setting is °F). Confirm the selection with .</p>
	<p>The temperatures in the display pane (item D1 in figure 7-1 on page 7-1) and settings pane Set (item D5 in the same figure) will be displayed with the newly selected unit. The display returns to its default mode. The Settings icon in the menu bar will go out.</p>

Process Protection

Process Protection kicks in when a program enters hold mode. When the temperature measured by the built-in sensor is found to depart from the set value by more than 0.5 °C (32.9 °F), the remaining time in hold mode is suspended until the temperature difference between the actual value and set value returns to less than 0.5 °C /32.9 °F).

Table 7-35 Toggling Process Protection On and Off

	<p>Press  to activate the menu bar, then use  or  to select the Settings icon and press  to confirm.</p>
	<p>The Error menu item from the Settings submenu appears in the multifunctional display pane.</p>
	<p>Press  to switch to the Protection menu item and confirm the selection with .</p>
	<p>In the selection screen that appears, press  to switch from On to Off state. To activate switch from Off to On state accordingly. Confirm the selection with .</p>
	<p>The display returns to its default mode. The Settings icon in the menu bar will go out.</p>

Program Preferences

The **Settings** ->**Program** menu item supports the preferences described in the following for the execution of user programs (see “Programming” on page 7-40.) used to control the oven’s operations. When a program terminates after running through one or more program cycles (see the section “Program Cycle Prompt” below), a single audible signal consisting of 5 beeps is given when no error condition is present. The oven is then switched off, unless the user has set the preferences to keep it running, as explained in the section “Mode after End (of Program)” on page 7-37.

Program Cycle Prompt

This menu item allows for enabling a prompt (deactivated when the oven ships from the factory) that asks for the number of times a program should be repeated (see “Launching a Program” on page 7-42) whenever the user launches a program.

Table 7-36 Activating / Deactivating the Program Cycle Prompt











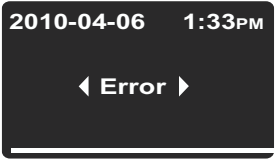
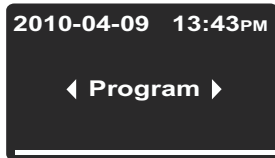

	<p>Press  to activate the menu bar, then use  or  to select the Settings icon and press  to confirm.</p>
	<p>The Error menu item from the Settings submenu appears in the multifunctional display pane.</p>
	<p>Press  to switch to the Program menu item and confirm the selection with .</p>
	<p>In the selection screen that appears, choose the preselected option Loops by pressing .</p>

Table 7-36 Activating / Deactivating the Program Cycle Prompt

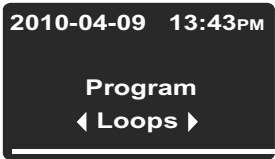
	<p>In the subsequent selection screen, enable the prompt (deactivated in “as shipped” state) by using  to move the selection from Off to On state and confirm the selection with .</p> <p>To deactivate the prompt, switch back from On to Off. Confirm your selection by pressing .</p> <p>When you choose Off, the oven is switched off after just one program cycle. You may change this default behavior by changing the “Mode after End (of Program)” preference explained in the next section.</p>
	<p>The display returns to its default mode. The Settings icon in the menu bar will go out.</p>

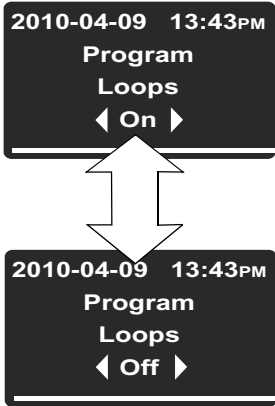
Mode after End (of Program)

Additionally this command allows for enabling a second prompt (also deactivated when the oven ships from the factory) that appears when the user launches a program and asks for the mode of operation the oven should continue to run upon completion of the program (see “[Launching a Program](#)” on page 7-42):

- **Off:** This option does not prompt the user to confirm before program start. It turns the device off when the program ends.
- **On:** When the user launches a program, this option prompts whether the oven should be turned off or continue to run in hold mode with the latest settings until the user acknowledges the end of the program.

An active weekly timer will be suspended until the **Program End** message is acknowledged. Upon resuming the timer, the oven will seek to establish the set value that was in place before the program was started (including fan speed and damper position).

Table 7-37 Changing the Mode after End













	<p>Press  to activate the menu bar, then use  or  to select the Settings icon and press  to confirm.</p>
	<p>The Error menu item from the Settings submenu appears in the multifunctional display pane.</p>

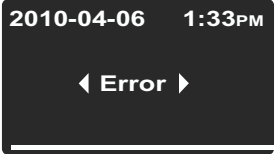
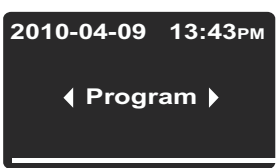

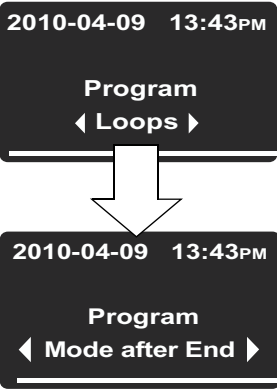

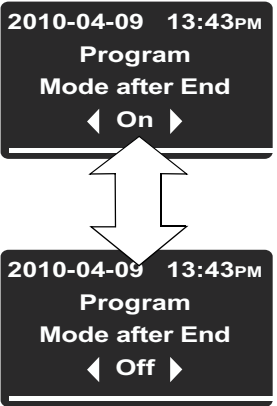
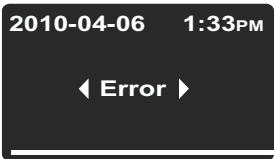
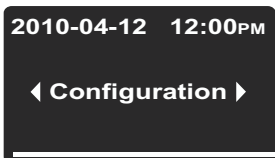

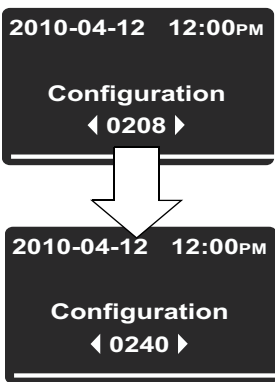





Table 7-37 Changing the Mode after End

	<p>Press  to switch to the Program menu item and confirm the selection with .</p>
	<p>In the selection screen that appears press  to switch from the preselected option Loops to Mode after End, then confirm the selection with .</p>
	<p>In the subsequent selection screen press  or  to switch between the On (Temperature Hold) and Off (factory default) states, then confirm the selection with .</p>
	<p>The display returns to its default mode. The Settings icon in the menu bar will go out.</p>

Configuration

The **Settings** -> **Configuration** menu item enables the user to enter a four-digit code that loads a specific set of operating parameters for the oven - for example, in order to make the voltage selection described in the section [“Connecting the RS-232 Interface”](#) on [page 5-11](#).

Table 7-38 Entering the Four-digit Code

	<p>Press  to activate the menu bar, then use  or  to select the Settings icon and press  to confirm.</p>
	<p>The Error menu item from the Settings submenu appears in the multifunctional display pane.</p>
	<p>Press  to switch to the Configuration menu item and confirm the selection with .</p>
	<p>The multifunctional display pane will present a prompt similar to the example shown at left, with the first digit of the four-digit configuration code flashing.</p> <p>Set the first digit of the configuration code using  (or ) and confirm your setting with . Set the remaining three digits exactly as described above.</p> <p>By confirming your entry for the last digit with , the new configuration is activated immediately.</p>
	<p>The display returns to its default mode.</p> <p>The Settings icon in the menu bar will go out.</p> <p>Enter the four-digit code '1234' to reset the user calibration.</p> <p>Enter the four-digit code '4321' to reset the sensor sample calibration.</p>



Programming

The menu item **Program** enables the user to create, store and launch up to 10 programs for automating workflows. Each of the 10 programs may consist of a maximum of 10 steps.

The following properties may be defined for each step, depending on the current hardware configuration:

- duration in hh:mm
- temperature set value
- fan speed level (1 through 5;
- damper position (0 through 3)

To ease the creation of programs users may choose to copy and edit existing programs.

End of Program

The end of a program is indicated by an audible signal (5 beeps). The oven is switched off or changes to Temperature Hold mode, as preset in the preferences under “[Changing the Mode after End](#)” on [page 7-37](#)). The display shows the message **Program End** as well as the temperature of the residual heat.

ECO Convenience Program (only for table-top units)

With Heratherm OGH-S Series and OMH-S Series ovens, the Eco convenience program allows for turning off an oven automatically from within an ongoing drying process as soon as the samples are dry. This requires that a sample sensor (accessory to be ordered separately) be connected to a dedicated port on the rear panel of the oven and inserted into the sample to be dried.

While the drying process is ongoing, the actual workspace temperature is continuously compared with the sample temperature measured by the sample sensor. At the beginning of the drying process, the cooling effect produced by evaporation prevents the sample from reaching the specific temperature limit preset during the Eco calibration routine. As soon as the entire humidity has evaporated from the sample to be dried, the sample sensor will measure a rise in temperature. If monitoring of the sample temperature indicates that the limit has been exceeded, the drying process is terminated and the oven shuts down automatically.

The temperature limit is computed from the differential between the actual workspace and sample temperatures, which means that it depends on the location of the sample in the device’s workspace and the temperature set value for the drying process. Therefore, using the Eco convenience program requires a previous Eco calibration of the sample sensor. This calibration routine should be repeated whenever the placement of the sample or the temperature set value for the drying process are varied in a significant way.

The Eco calibration result is factored into the program termination criteria only and does not have any impact on the sample sensor temperature readout in the multifunctional display pane.

Preparing the Oven for the Eco Convenience Program - Carrying Out Eco Calibration

1. Connect the sample sensor to the port on the rear panel of the oven, then insert it through the tube access port (also found on the rear panel of the device) into the oven's workspace. The multifunctional display pane shows the temperature measured by the sample sensor.
2. Mount the sample sensor at the intended location of the sample to be dried in the device's workspace.

Note The sample to be dried must not be placed in the oven's workspace for carrying out Eco calibration.

3. Set the temperature set value for the future drying process on the oven.
4. Adjust the damper to position 3 so it is fully opened – as would be the case during the drying process.
Once the intended temperature set value has been reached, allow for a 2 hour wait period so the oven can establish a stable thermal state.
5. Choose the **Eco** option from the **Settings -> Calibration** menu and confirm with  .
Eco calibration will start now.

Loading the Oven with the Sample to be Dried

1. Allow the oven to cool down.
2. Place the sample to be dried at the location in the workspace for which the most recent Eco calibration has been carried out.
3. Insert the sample sensor into the sample.

Eco Convenience Program Flow

1. On the oven set the temperature set value for the drying process for which you have carried out the most recent Eco calibration.
2. Launch the Eco program as explained in [table 7-39, "Launching a Program," on page 42](#). Choose the Eco option instead of P1...P10. None of the possible prompts will appear in that case. While the Eco convenience program is running, the multifunctional display pane reads **Eco**.
3. Once the oven's built-in controller has established the workspace temperature at the specified set value, monitoring for the sample temperature limit starts.
4. The drying process ends when the temperature limit is exceeded. The end of the program is indicated by an audible signal (5 beeps), an **Eco End!** message appears in the multifunctional display pane, and the oven turns off automatically.

Instructions

Table 7-39 Launching a Program















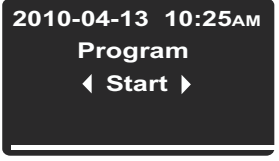

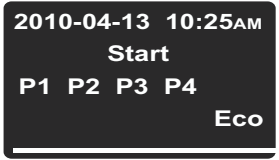

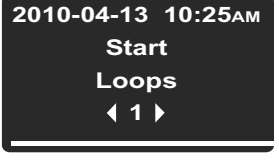

	<p>Press  to activate the menu bar, then use  or  to select the Program icon and press  to confirm.</p>
	<p>In the selection screen shown at left, choose the preselected option Start by pressing .</p>
	<p>Stop Timer Prompt Upon Launching a Program When a timer is running, an additional Stop Timer prompt appears at this point (see “Stopping an Off Timer Before It Expires” on page 7-14.). Choosing Yes aborts the timer and launches the selected program. Choosing No allows the timer to continue running. However, when a user program and a timer overlap, the program about to launch has priority over the timer, that is, the timer will be put on hold and execute only after the program has finished.</p>
	<p>In the list of existing programs (for example: P1...P4) shown at left, maintain the default selection P1 or choose another program using  (or ). In either case, press  to launch the program.</p>
	<p>If activated in the preferences for programs (see “Activating / Deactivating the Program Cycle Prompt” on page 7-36.), the Loops prompt appears, asking for the desired number of program cycles (= Loops). Set the number of cycles by using  or  (default is “1” for one cycle) and confirm with .</p>
	<p>If activated in the preferences for programs (see “Changing the Mode after End” on page 7-37.), the Mode after End prompt will appear. You may use this dialog to select the desired mode of operation after a program has finished executing, that is, to have the oven turn off or go to hold mode when the program ends. Use  or  to choose the desired mode of operation and confirm the selection with .</p>

Table 7-39 Launching a Program

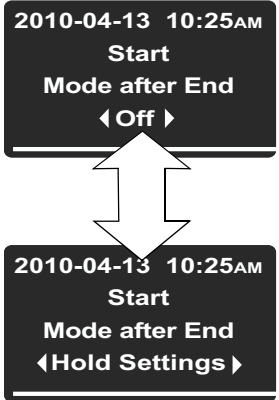
	<p>The multifunctional display pane presents a progress bar for the selected program, similar to the example shown at left.</p> <p>The functions of the display elements are explained in table 7-41 on page 7-44 below.</p>
	<p>The Program icon in the menu bar is illuminated to indicate that a user program is running.</p>

The functions of the display elements (save for the date and time fields; see [table 7-2 on page 7-3](#)) are explained in the following table.

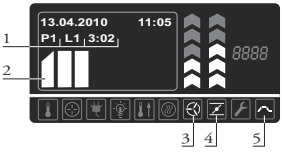
Table 7-40 Display Elements Active during Program Execution

No.	Function
1	<p>These three fields show the following program execution information:</p> <ul style="list-style-type: none"> - ID of the active program - for example: P1 for Program 1 - number of the current program cycle - for example, L1 for the first cycle (appears only when the prompt for the number of program cycles is active; see “Program Cycle Prompt” on page 7-36) - overall remaining time - for example: 3:02 <p>Note The remaining time does not include any phases whose duration has been set to 00:00 in order to achieve rapid heat-up or cool-down of the oven.</p>
2	<p>This bar graph uses a variable number of bars to represent the progress of program execution: Three bars - for example, indicate step No. 3, four bars step No. 4 of a program, etc. Up to 10 bars may appear in this place, equivalent to a maximum of 10 steps (see above).</p>
3	<p>The Fan icon is illuminated to indicate that the fan has been turned on for the current step of the program. The fan speed level can be determined from the bar graph located directly above the icon (see table 7-2 on page 7-3).</p>
4	<p>The Damper icon is illuminated to indicate that the fan damper has been opened for the current step of the program. The damper position can be determined from the bar graph located directly above the icon (see table 7-2 on page 7-3).</p>
5	<p>The Program icon in the menu bar is illuminated to indicate that a user program is running.</p>

Table 7-41 Aborting a Program







	<p>While a program is running (as indicated by the flashing bar, program number and remaining time counter in the multifunctional display pane and the Program icon illuminated in the menu bar) press  or .</p>
	<p>When the prompt shown at left appears in the multifunctional display pane, press  to choose the Yes option and confirm the selection with .</p>
	<p>The display returns to its default mode. The Program icon in the menu bar will go out.</p>

Table 7-42 Creating a New Program

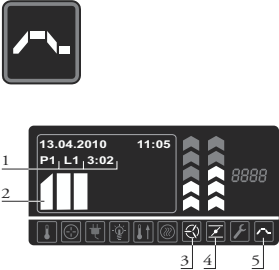

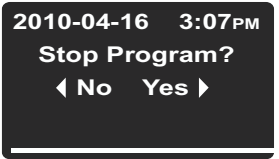







	<p>Press  to activate the menu bar, then use  or  to select the Program icon and press  to confirm.</p>
	<p>In the selection screen that appears press  to switch from the preselected option Start to New, then confirm the selection with .</p>
	<p>In the following selection screen maintain the default selection (for example P4) or choose any other program from the list of free program memory slots (example at left shows free memory slots at P4...P10) using  (or ).</p> <p>In either case press  to start creating a new program.</p>

Table 7-42 Creating a New Program

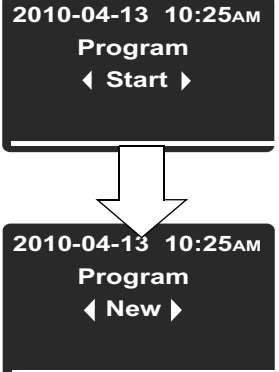

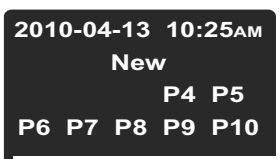







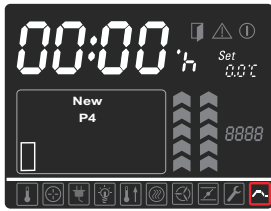

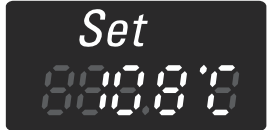

	<p>A programming screen appears for the first step of the program, which is represented by a flashing empty bar. If the first step is supposed to last longer than an hour (up to 23 hours are supported), use  to set the hour count for the duration of the first step and confirm your settings with .</p> <p>Then, set the minute count using  (or press :00 accept zero minutes) and confirm your settings with .</p>
	<p>Setting the Duration of a Program Step</p> <p>By letting the duration of the step default to 00:00, you instruct the oven to heat up or cool down to the temperature set value as fast as possible. If you enter a time span, the oven will rather try to reach the set value along a continuously rising or falling ramp curve. For each step that involves a temperature change, the ramp is visually represented by a slanted top of the progress bar.</p>
	<p>The selection moves on to the settings pane Set, which will start flashing.</p> <p>Use  to set the desired temperature set value and confirm your settings with .</p> <p>Note If you need to set up a program that involves a subsequent cool-down phase, you may want to consider programming the last step with a set temperature value of 0 °C (32 °F) to speed up cool-down. For details and instructions see “Temperature Set Value” on page 7-7.</p>
	<p>The selection moves on to the bar graph for the fan speed, which will start flashing.</p> <p>If you want the fan to run at more than 20% of its maximum speed for the duration of the current program step, use  to set the desired fan speed level and confirm your settings with .</p>
	<p>The selection moves on to the bar graph for the damper, which will start flashing.</p> <p>If you want the damper to remain open for the duration of the current program step, use  to select the desired damper position and confirm your settings with .</p>

Table 7-42 Creating a New Program





	<p>The Next prompt appears in the multifunctional display pane.</p> <p>If you wish to create an additional program step, press the button .</p> <p>The display returns to the initial stage of program creation. Now, the second bar will be flashing, representing the second program step.</p> <p>If you do not wish to create an additional program step, press  or  to continue to the Save option, then press  one more time to save the newly created program.</p>
	<p>The display returns to its default mode.</p> <p>The newly created program may be launched now, as described in “Launching a Program” on page 7-42.</p>

Table 7-43 Deleting an Existing Program



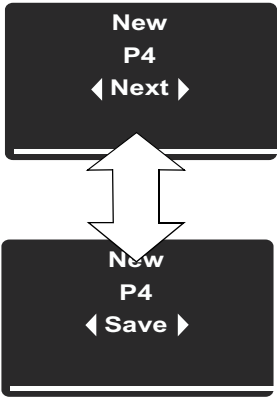





	<p>Press  to activate the menu bar, then use  or  to select the Program icon and press  to confirm.</p>
	<p>In the selection screen shown at left, press  to switch to the Delete option.</p>
	<p>In the list of existing programs (for example: P1...P4; default selection is P1) shown at left, choose any program by pressing , then press  to confirm the deletion.</p>

Table 7-43 Deleting an Existing Program

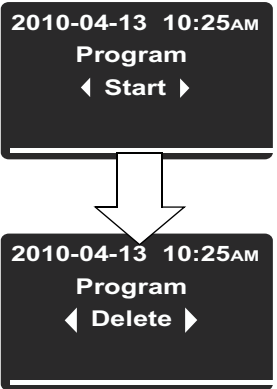

	<p>In the confirmation dialog for the deletion that appears, press  to choose the Yes option (default selection is No), then press  to have the deletion carried out.</p>
	<p>The display returns to its default mode. The program memory is free to accept a new or copied program (see “Creating a New Program” on page 7-44 and the procedure described below under “Copying an Existing Program”).</p>

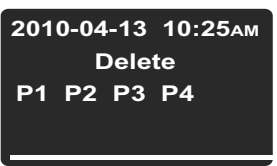
Table 7-44 Copying an Existing Program





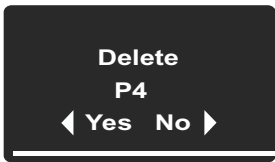





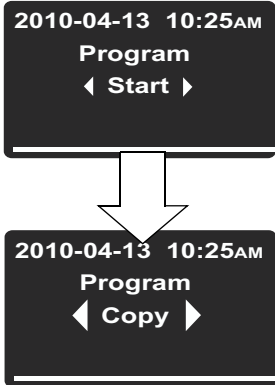

	<p>Press  to activate the menu bar, then use  or  to select the Program icon and press  to confirm.</p>
	<p>In the selection screen shown at left, press  to switch to the Copy option.</p>
	<p>In the list of existing programs (for example P1...P4; default selection is P1) shown at left, choose any program by pressing , then press  to start copying.</p>
	<p>In the list of free program memory slots in the selection screen that appears (for example: P5...P10) press  to choose a target slot for copying, then press  to confirm the copy target.</p>

Table 7-44 Copying an Existing Program

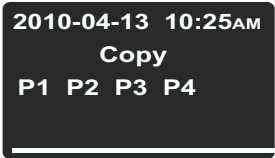

	<p>In the confirmation dialog for copying that appears, press  to choose the Yes option (default selection is No), then press  to confirm copying.</p>
	<p>The display returns to its default mode. The program you have just copied to the targeted memory slot may be edited now to adapt it to specific needs (see the procedure described below under “Editing an Existing Program”).</p>

Table 7-45 Editing an Existing Program





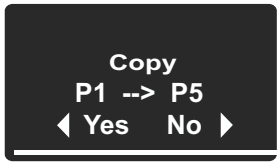









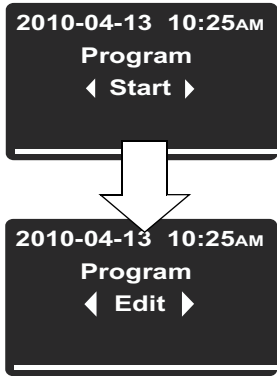

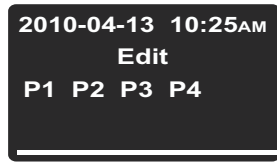
	<p>Press  to activate the menu bar, then use  or  to select the Program icon and press  to confirm.</p>
	<p>In the selection screen shown at left, press  to switch to the Edit option.</p>
	<p>In the list of existing programs (for example: P1...P4; default selection is P1) shown at left, choose the program you wish to edit by pressing , then press  to confirm the selection.</p>

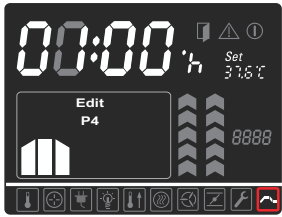
Table 7-45 Editing an Existing Program

	<p>In the programming screen that appears, choose the first program step for editing by pressing  or use  to navigate to another program step and select it by pressing .</p> <p>Edit the duration, temperature set value, fan speed and damper position as explained under “Creating a New Program” on page 7-44.</p> <p>When you are done with the last edit, you may press either  to go to the next program step or  to cycle through all settings for the step you have just edited. If this is the last step, you will be presented with the following prompt for saving your changes.</p>
	<p>When prompted for saving your changes, press  to choose the Yes option (default selection is No), then press  to confirm saving.</p>
	<p>After confirming and saving, the multifunctional display pane will return to the flashing bar for the current program step.</p>

Handling and Control
Floor mounted units

Shut-down

This chapter provides instructions for shutting the oven down for prolonged periods of time, that is, at least for several days in a row.



Shutting the Oven Down

1. Remove the containers with the samples and all accessories from the work space.
2. Turn the oven off using the control panel.
3. Unplug the power cord and secure it against accidental reconnection.
4. Until the oven is shut down, the work space must be continuously ventilated. Leave the door open and secure it against accidental closure.

**Shut-down
Shutting the Oven Down**

Cleaning and Disinfection

Cleaning

		Incompatible cleaners
		<p>Some oven components are made of plastics. Solvents may attack plastics. Strong acids or alkaline solutions may cause embrittlement of plastics.</p>
		Moisture-sensitive components
		<p>Do not spray cleaning agent onto the control panel and the control box at the rear of the oven. When wiping the oven clean, always make sure that no moisture enters into these components. Wipe the display window down with a slightly dampened cloth, then wipe dry with a rag made of 100% microfiber.</p>

Cleaning Exterior Surfaces

Remove dirt residues and depositions thoroughly using a solution of lukewarm water and commercial detergent.





Wipe the surfaces clean using a clean cloth and clear water.

Then, wipe the surfaces dry using a clean cloth.



Wipe / Spray Disinfection



The manual wipe and spray disinfection is the following process:

- predisinfection
- cleaning as appropriate for the current application.

		Alcoholic disinfectants!
<p>Disinfectants having an alcohol content of more than 10% may form, in combination with air, easily combustible and explosive gas mixtures.</p>		
<p>When using such disinfectants, avoid open flames or exposure to excessive heat during the entire disinfection process!</p>		
<p>Use such disinfectants only in adequately ventilated rooms.</p>		
<p>After the disinfectant has been allowed to react, wipe the cleaned oven components thoroughly dry.</p>		
<p>Observe safety regulations to avoid fire and/or explosion hazard caused by alcohol-containing disinfectants.</p>		
		Chloride-containing disinfectants!
<p>Chloride-containing disinfectants can corrode stainless steel and galvanized metal surfaces.</p>		
<p>Use only disinfectants that do not affect stainless steel and galvanized metal surfaces!</p>		

Preparing the manual wipe/spray disinfection

		Electrical shock
<p>Contact with live electrical components may cause a lethal electric shock.</p>		
<p>Before connecting the oven to the power supply, check the power cord and the plug for damage. Do not use damaged cables for connecting the oven to the power source!</p>		

	 WARNING	Health hazard
	<p>The surfaces of the work space may be contaminated. Contact with contaminated cleaning liquids may cause infections. Disinfectants may contain harmful substances.</p> <p>When cleaning and disinfecting, always observe the safety instructions and hygiene guidelines!</p> <p>Wear safety gloves.</p> <p>Wear safety goggles.</p> <p>Wear mouth and respiratory system protection gear to protect your mucous membranes.</p> <p>Observe the safety instructions of the disinfectant's manufacturer and the hygiene supervisor.</p>	

Predisinfection

1. Remove all samples from the work space and store them in a safe place.
2. Spray disinfectant onto the surfaces of the work space and of the accessories or wipe the surfaces clean using disinfectant.
3. Allow time for the disinfectant to act as specified by the manufacturer.

 NOTE	Moisture-sensitive components
Spray the sensor with disinfectant.	

Maintenance

Regular maintenance is mission-critical to avoid malfunctions due to ageing and wear. Failure to perform maintenance on a regular basis may result in:

- deviations in heating performance
- loss of control over temperature distribution throughout the work space
- damage to samples

Inspections and checks

To ensure the operational performance and safety of the oven, their functions and the components listed below must be checked at regular intervals.

Regular Checks

- Check the oven for overall cleanliness and remove any debris from previous processes.
- To avoid operation without an appropriate fresh air supply, check the air filter (accessory to be ordered separately) in the air inlet for contamination.

Weekly Inspection

- Check integrity and proper seating of the door seal.

Note If the oven is operated above a certain temperature limit (see [“Replacing the Door Seal”](#) on [page 10-3](#)), the door seal must be replaced after three (3) months (keep a unit logbook).

- Swap air filter cartridge (optional) in air inlet.
- Perform functional check of the control panel and of the oven’s built-in controller.
- Perform electrical safety check in accordance with the relevant national regulations.

NOTE

Functional check

If safety devices were removed or disabled for inspections, the oven must not be operated before the safety devices have been reinstalled and checked for their correct function.

	<div style="border: 1px solid black; padding: 5px;"> WARNING</div> <p>Spare Parts and User Modifications</p> <p>To avoid major malfunctions of the oven and associated safety hazards that may result in death, serious injuries, or damage to the oven and other equipment, use spare parts approved by Thermo Electron LED GmbH only. Third-party spares without approval void the limited warranty.</p> <p>Do not modify the oven in any way without obtaining the prior written authorization from Thermo Electron LED GmbH. Unauthorized modifications may compromise operational safety and give rise to hazards that may result in death, serious injuries, or damage to the oven and other equipment.</p>
--	--

Service Intervals

During ongoing operation, the following service work must be performed:

3-monthly service

Perform the comparative temperature measurement outlined in the following section.

Annual service

Have the oven inspected and serviced by an authorized Technical Service agent.

	<div style="border: 1px solid black; padding: 5px;"><div style="background-color: #0070C0; color: white; padding: 5px; display: inline-block;">NOTE</div> Service contract</div> <p>Thermo Electron LED GmbH offer a product-specific service contract comprising all necessary tests and service work.</p>
--	---

Preparing Temperature Calibration

To determine the exact measured value of the oven's integral temperature sensor, a temperature comparison measurement must be performed every three months. If a major temperature deviation is found during this check, temperature calibration is required. During this process, the temperature controller of the oven is set to the value measured during the temperature comparison measurement.

Use a calibrated measuring instrument with an accuracy of $< \pm 1 \text{ }^\circ\text{C}$ ($1.7 \text{ }^\circ\text{F}$) for this test.

To minimize temperature variations during the measurement, put the measuring sensor in an isothermal container (such as a bowl filled with glycerol) before placing it in the work space. Use the center of the work space as the reference location for the comparison measurement.

	NOTE	Isothermal Container Do not use a container filled with water as an isothermal container because the evaporation of water will result in a lower temperature reading.
--	-------------	---

Comparison Measurement Procedure

1. Turn the oven on using the power switch.
2. Set the temperature set value and allow the oven to stabilize. This may take several hours.
3. Place the measuring device in the center area of the wire-mesh shelf in the center area of the work space. Route the connecting cable through the air exit in the rear panel of the oven.
4. Close the door.
5. Wait until the temperature value displayed on the measuring instrument has stabilized.
6. In case the temperature readings on the measuring device and the oven's display do not match exactly, use the temperature reading from the measuring device to calibrate temperature control, as explained in [“Entering the Calibration Reference Temperature Manually”](#) on page 7-28.

Temperature Calibration Procedure

For detailed instructions on how to perform a manual or automatic temperature calibration, please refer to the instructions in the section [“Calibration”](#) on page 7-27 .

	NOTE	Excessive Work Space Temperatures Excessive work space temperatures subsequent to a calibration run can be reduced by leaving the door open for approx. 30 seconds.
--	-------------	---

Replacing the Door Seal

The door seal of the outer door is located in the retaining slot. The door seal should be inspected for any signs embrittlement every six months when the oven has been used at maximum temperatures of up to 250 °C / 482 °F or every three months when the oven has been used at maximum temperatures beyond 250 °C / 482 °F.

No tools are required to replace the seal.

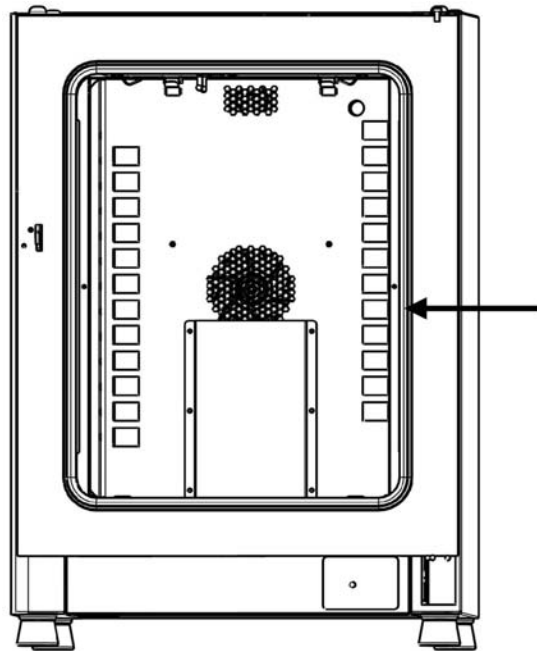

Figure 10-1 Door seal replacement (example showing OMH Series oven)

1. Pull the seal out of the guide slot.
2. Starting on the hinge side of the door, position the seam of the new seal at the location indicated by the arrow in [figure 10-1](#).
3. Gently press the seal into the slot, working around the circumference of the door. In doing so, be careful not to stretch the seal.
4. Make sure that the retaining rail taper is positioned correctly in the slot and that the seal is flush with the door frame.



Replacing the Power Cord

When the device's power cord is damaged, it must be replaced with an original spare part. Using a standard power cord with a lower temperature withstand class is prohibited.

Returns for Repair

Prior to returning any materials, please contact our Customer Service Department for a "Return Materials Authorization" number (RMA).

Material returned without an RMA number will be refused.

	<div data-bbox="523 257 906 353"> WARNING</div> <p data-bbox="927 282 1238 315">Contamination hazard</p> <p data-bbox="518 376 1385 477">The oven may have been used for treating and processing infectious substances, which may have caused contamination of the oven and its components.</p> <p data-bbox="518 479 1334 546">Prior to return shipment, it is therefore mandatory that all oven components be properly decontaminated.</p> <ul data-bbox="539 568 1394 763" style="list-style-type: none">• Clean the oven components thoroughly, then disinfect or decontaminate them (depending on application).• Fill in and attach a safety declaration with details on decontamination activities performed to the items that are to be repaired.
---	--

**Maintenance
Returns for Repair**

Disposal

	<div style="border: 1px solid black; padding: 5px;">  WARNING </div> <p>Contamination hazard</p> <p>The oven may have been used for treating and processing infectious substances, which may have caused contamination of the oven and its components. Prior to disposal, it is therefore mandatory that all oven components be properly decontaminated.</p> <ul style="list-style-type: none"> • Clean the oven components thoroughly, then disinfect or decontaminate them (depending on application). • Attach a declaration of decontamination with details on decontamination activities performed to the items that are to be disposed of.
--	---

Overview of Materials Used

Component	Material
Thermal insulation components	Glass wool
Printed circuit boards	Coated electrical components contain various plastics materials. Components mounted on circuit boards containing epoxy resin bonder.
Plastic components, general	see material labelling
Exterior housing	Galvanized steel sheet, painted
Oven rear panel	Galvanized steel sheet
Outer door	Galvanized steel sheet, painted
Door inner panel	OMH and OGH: stainless steel 1.4301
Control panel and display window protective foil	Polyethylene
Heater	Stainless steel-sheathed resistance heater wires
Work space containers	Stainless steel 1.4301
Wire-mesh shelves	Steel, chrome-plated

Disposal
Overview of Materials Used

Component	Material
Door frame seal	Silicone
Fan wheel	Stainless steel 1.4016 (OMH Series and OMH-S Series only)
Cables	Plastic-sheathed stranded copper wire
Packaging	Corrugated board, polyethylene film, and styrofoam, chemically untreated wood

Error Codes

Table 12-1 below lists the error messages that may appear in the control panel display window (see “Error Log” on page 7-26) and provides instructions for clearing such alarms.

Table 12-1 Heratherm Oven Error Codes

Error Message & Code	Root Cause	Alarm Response	Alarm Clearing Instructions
Door Open Error (E001)	The door switch (OGH-S Series and OMH-S Series only) has triggered an alarm because the door has been open for more than 10 minutes. Alarm activated.	Audible alarm activated, alarm relay energized, message shown on display.	Close the door.
Display Error (E002)	Display communication error. The built-in controller was unable to restore communication with the control panel.	Audible alarm activated, alarm relay energized, message shown on display. Reset after 30 s.	Power cycle the device by unplugging, then reconnecting the power cord. If this doesn't solve the problem, call service.
Mirrored Parameter Loaded (E003)	The controller was unable to read the user-specific settings and had to resort to an emergency parameter set held in mirrored storage.	Audible alarm activated, alarm relay energized. Fallback to mirrored parameter storage. Device continues to run without loss of functionality, including user-specific settings.	Check the latest settings, for example the set value.
Factory Parameter Loaded (E004)	The controller was unable to read the mirrored parameter set and had to resort to factory-preset parameters.	Fallback to factory-preset parameters. Audible alarm activated, alarm relay energized, message shown on display. User-specific settings may be lost - for example, the temperature display unit preference, or user programs.	Acknowledge by pressing ESC . Re-enter customer-specific settings.
Default Parameter Loaded (E005)	The controller was unable to read the factory-preset parameters and had to resort to default settings	Fallback to default parameters, audible alarm activated, alarm relay energized, message shown on display. The device is completely inoperative.	Call service.
Power Down Error (E007)	Power has been cut off (power outage) while the device was running.	Audible alarm activated, alarm relay energized, message shown on display.	Check the power supply. Power up then device, then acknowledge the alarm by pressing ESC .

Table 12-1 Heratherm Oven Error Codes



Error Message & Code	Root Cause	Alarm Response	Alarm Clearing Instructions
Program Error (008)	Error in processing a user program.	Program is aborted. Audible alarm activated, alarm relay energized.	Acknowledge by pressing (ESC).
Fan Error (E009)	Fan speed out of range. ((OMH Series and OMH-S Series only)	Audible alarm activated, alarm relay energized, message shown on display. Heater disabled by controller.	Acknowledge by pressing  . Increase or decrease fan speed on control panel. If this doesn't solve the problem, call service.
Damper Error (E010)	Undefined damper position.	Audible alarm activated, alarm relay energized, message shown on display.	Acknowledge by pressing  . Adjust damper position on control panel. If this doesn't solve the problem, call service.
Config Error (E012)	General device configuration error.	Audible alarm activated, alarm relay energized, message shown on display. The device is completely inoperative.	Call service.
OTP Error (E013)	Klixon contact has tripped.	Overtemperature Protection fault. Audible alarm activated, alarm relay energized, message shown on display. Bridging across Klixon contact has failed. (Klixon contact has tripped)	Call service.
Incorrect voltage (E014)	The applied voltage is too high or too low.	Audible alarm activated, error message shown on display.	Apply the correct voltage as indicated on the nameplate and acknowledge the error.
Sensor Error (E100)	Process sensor damaged. The actual measured value is out of range.	Audible alarm activated, alarm relay energized, message shown on display. Control transferred to reference sensor. If both sensors are defective, disable all control circuits.	Call service.
Temperature too high (E101) (actual value exceeds setpoint (heater defective))	Actual measured value exceeds permissible range. The Triac is defective.	Process protection activated, control continues on set value. Audible alarm activated, alarm relay energized, message shown on display.	Call service.
Temperature too low (E102) (only on devices equipped with a door switch). OGH-S and OMH-S only.	Actual measured value falls short of permissible range. The mains voltage may be too low.	Audible alarm activated, alarm relay energized, message shown on display. Temperature control continued.	Check the AC mains supply for an undervoltage condition and have the problem remedied, if necessary. If this doesn't solve the problem, call service.

Table 12-1 Heratherm Oven Error Codes

Error Message & Code	Root Cause	Alarm Response	Alarm Clearing Instructions
Temperature not plausible (E103)	The difference between the control and reference sensors exceeds the maximum permissible deviation, rendering the measurement implausible.	Device uses the sensor that indicates the higher temperature for servo control. Audible alarm activated, alarm relay energized, message shown on display. Error can be acknowledged and doesn't reset.	If the problem does not go away, call service.
Calibration value too high (E104)	The calibration reference value calculated on the basis of the user input falls short of the upper limit for calibration references.	Fallback to previous calibration reference. Audible alarm activated, alarm relay energized, message shown on display.	Check the external reference sensor for proper function and replace, if necessary. If this doesn't solve the problem, call service.
Calibration value too low (E105)	The calibration reference value calculated on the basis of the user input exceeds the lower limit for calibration references.	Fall back to previous calibration reference. Audible alarm activated, alarm relay energized, message shown on display.	Check the external reference sensor for proper function and replace, if necessary. If this doesn't solve the problem, call service.
Constant sensor signal (E106)	None of the decimal places of the A/D-converter output for the process sensor has changed over a specific time period.	Control transferred to reference sensor. Audible alarm activated, alarm relay energized, message shown on display. If both sensors are defective, all control circuits will be disabled.	Call service.
Constant reference sensor signal (E107)	None of the decimal places of the A/D-converter output for the process sensor has changed over a specific time period.	Control continues on process sensor, audible alarm activated, alarm relay energized, message shown on display. If both sensors are defective, all control circuits will be disabled.	Call service.
Constant sample sensor signal (E108)	None of the decimal places of the A/D-converter output for the process sensor has changed over a specific time period.	Audible alarm activated, alarm relay energized, message shown on display.	Call service.
Heating relay error (E109)	The voltage measurement has indicated a defect in the heater circuit relay.	Device completely inoperative, audible alarm activated, alarm relay energized, message shown on display.	Be sure to pull the power plug and disconnect the device from the AC mains. Call service.
Heating triac error (E110)	The voltage measurement has indicated a defect in the triac.	Audible alarm activated, alarm relay energized, message shown on display. Audible alarm returns upon acknowledgement.	Call service.

Table 12-1 Heratherm Oven Error Codes

Error Message & Code	Root Cause	Alarm Response	Alarm Clearing Instructions ¹
Temperature too high (E111)	Actual measured value exceeds permissible range.	Audible alarm activated, alarm relay energized, message shown on display. Heater turned off until upper limit of hysteresis is recovered. Servo control operations continue. Alarm can be acknowledged, and goes away when the difference between the actual and set values ceases to exist. Note: This error does not indicate a defective triac.	Open the door to speed up cool-down. Check whether the device was loaded with a hot object, if so, remove. Ensure that the equipment was operated with at least one perforated shelve and with the door not opened longer than 10 min. If this doesn't solve the problem, call service.
Sensor error (E112)	The measured actual value is out of range.	Audible alarm activated, alarm relay energized, message shown on display. Control continues on process sensor. If both sensors are defective, disable all control circuits.	Call service.
Sensor error (E113)	The measured actual value is out of range.	Audible alarm activated, alarm relay energized, message shown on display.	Call service.
ADC error (E114)	A/D converter does not supply a plausible output.	Audible alarm activated, alarm relay energized, message shown on display.	Call service.
Watchdog error (E115)	Watchdog test failed on power-up.	Audible alarm activated, alarm relay energized, message shown on display.	Call service.

1. The rectification of an error is deemed to have been successful when the audible alarm stops sounding, the alarm relay drops out and the message disappears from the control panel display.

Technical Data

The technical data are valid only for an empty device equipped with three shelves, a spray-painted outer enclosure and a power line voltage 230 V/50 Hz. Options may have an impact on the specified performance.

Table 13-1 Technical Data - OGH and OGH-S Series

Parameter	Unit	OGH 60	OGH 100	OGH 180	OGH-S 60	OGH-S 100	OGH-S 180
Process							
Work Space Atmosphere Min. ¹	°C/°F	50/122	50/122	50/122	50/122	50/122	50/122
Max.	°C/°F	330/626	330/626	330/626	330/626	330/626	330/626
Temperature deviation from set value at 150 °C (302 °F), spatial. Max. value/ Typical value	K	±3 / ±2.5	±3.5 / ±3	±3 / ±2.5	±3 / ±2.5	±3.5 / ±3	±3 / ±2.5
Temperature deviation from set value at 150 °C (302 °F), over time, Max. value/Typical value	K	±0.3 / ±0.3	±0.4 / ±0.3	±0.3 / ±0.3	±0.3 / ±0.3	±0.4 / ±0.3	±0.3 / ±0.3
Heat-up time (work space unoccupied, from 25 °C (77 °F) to 98% of set temperature of 150 °C/302 °F)	min	22/20	25/22	25/22	22/20	25/22	25/22
Recovery time (work space unoccupied, door open for 30 s, to set temperature). Max.value/Typical value	min	9/8	10/8	9/8	9/8	10/8	9/8
Heat-up time with boost heat active (to set temperature of 300 °C/572 °F)	min	35	26	41	35	26	41
Heat dissipation to environment (at set temperature of 150 °C (302 °F) and room temperature of 25 °C/77 °F)	W	170 ± 10%	210 ± 10%	290 ± 10%	170 ± 10%	210 ± 10%	290 ± 10%
Max. air change at 150 °C/302 °F	h ⁻¹	26	14	17	26	14	17
Overall dimensions							
Height	mm/in	720/ 28.3	820/ 32.3	920/ 36.2	720/ 28.3	820/ 32.3	920/ 36.2

Table 13-1 Technical Data - OGH and OGH-S Series

Parameter	Unit	OGH 60	OGH 100	OGH 180	OGH-S 60	OGH-S 100	OGH-S 180
Width	mm/in	530/ 20.8	640/ 25.2	640/ 25.2	530/ 20.8	640/ 25.2	640/ 25.2
Depth	mm/in	565/ 25.2	565/ 25.2	738/ 29.1	565/ 25.2	565/ 25.2	738/ 29.1
Overall weight	kg/lbs	44/97	55/121	69/152	44/97	55/121	69/152
Loading capacity							
Loading capacity per shelf	kg/lbs	25/55			25/55		
Max. overall loading capacity per device	kg/lbs	50/110	50/110	75/165	50/110	50/110	75/165
Electrical data							
Power rating	W	1810	3100	3100	1810	3100	3100
Maximum current	A	7.9	13.5	13.5	7.9	13.5	13.5
Earthing system (e.g. 1/N/PE)		1/N/PE	1/N/PE	1/N/PE	1/N/PE	1/N/PE	1/N/PE
Power line frequency	Hz	50/60			50/60		
Power line voltage +/- 10 %	V	230	230		230	230	
IP protection system		IP 20			IP 20		
Protection class		I			I		
Overvoltage category as per IEC 60364-4-443		II			II		
Device fusing, building side	A	16			16		
Device fusing, on PCB	A	2 x 16			2 x 16		
Environmental conditions							
Min. ambient temperature	°C/°F	18/65			18/65		
Max. ambient temperature	°C/°F	32/90			32/90		
Max. humidity in service, non condensing	% r.F./ % r.H.	80, non condensing			80, non condensing		
Min. storage temperature	°C/°F	20/68			20/68		
Max. storage temperature	°C/°F	60/140			60/140		
Max. humidity in storage, non condensing	% r.F./ % r.H.	90, non condensing			90, non condensing		
Post-transport acclimation time	h	2			2		
Noise level	dB(A)	34			34		
Degree of pollution as per IEC EN 61010-1		2			2		
Site conditions							
Maximum altitude above sea level	m/y ASL	2000/2187			2000/2187		
Minimum side clearance	mm/in	50/2			50/2		

Table 13-1 Technical Data - OGH and OGH-S Series

Parameter	Unit	OGH 60	OGH 100	OGH 180	OGH-S 60	OGH-S 100	OGH-S 180
Minimum front clearance	mm/in	590 / 23.2	690 / 27.2	814 / 32	590 / 23.2	690 / 27.2	814 / 32
Minimum back wall clearance	mm/in	80/3.2			80/3.2		
Minimum bottom clearance	mm/in	200/8			200/8		
Minimum top clearance	mm/in	300/12			300/12		

¹ Temperatures as low as ambient +10 °C can be selected, this requires open damper and no additional heat in unit.

Table 13-2 Technical Data - OMH-S and OMH Series

Parameter	Unit	OMH 60	OMH 100	OMH180	OMH 60-S	OMH 100-S	OMH 180-S
Process							
Work Space Atmosphere Min. ¹	°C/°F	50/122	50/122	50/122	50/122	50/122	50/122
Max.	°C/°F	330/626	330/626	330/626	330/626	330/626	330/626
Temperature deviation from set value at 150 °C (302 °F), spatial. Max. value/Typical value.	K	±2.2 / ±1.8	±1.5 / ±1.3	±2.2 / ±1.8	±2.2 / ±1.8	±1.5 / ±1.3	±2.2 / ±1.8
Temperature deviation from set value at 150 °C (302 °F), over time, Max. value/Typical value.	K	±0.25/±0.2	±0.25/±0.2	±0.25/±0.2	±0.25/±0.2	±0.25/±0.2	±0.25/±0.2
Heat-up time (work space unoccupied, from 25 °C (77 °F) to 98% of set temperature of 150 °C/302 °F) Max. value/Typical value	min	20/18	18/16	20/18	20/18	18/16	20/18
Recovery time (work space unoccupied, door open for 30 s, to set temperature). Max. value/Typical value.	min	5/4	5/4	5/4	5/4	5/4	5/4
Heat-up time with boost heat active (to set temperature of 300 °C/572 °F)	min	41	25	36	41	25	36
Heat dissipation to environment (at set temperature of 150 °C (302 °F) and room temperature of 25 °C/77 °F)	W	259 ± 10%	358 ± 10%	424 ± 10%	259 ± 10%	358 ± 10%	424 ± 10%
Max. air change at 150 °C/302 °F	h ⁻¹	33	56	32	33	56	32

Table 13-2 Technical Data - OMH-S and OMH Series

Parameter	Unit	OMH 60	OMH 100	OMH180	OMH 60-S	OMH 100-S	OMH 180-S
Overall dimensions							
Height	mm/in	720/ 28.3	820/ 32.3	920/ 36.2	720/ 28.3	820/ 32.3	920/ 36.2
Width	mm/in	530/ 20.8	640/ 25.2	640/ 25.2	530/ 20.8	640/ 25.2	640/ 25.2
Depth	mm/in	565/ 25.2	565/ 25.2	738/ 29.1	565/ 25.2	565/ 25.2	738/ 29.1
Overall weight	kg/lbs	44/97	55/121	69/152	44/97	55/121	69/152
Loading capacity							
Loading capacity per shelf	kg/lbs	25/55			25/55		
Max. overall loading capacity per device	kg/lbs	50/110	50/110	75/165	50/110	50/110	75/165
Electrical data							
Power rating	W	1400	3060	3060	1400	3060	3060
Maximum current	A	6.1	13.3	13.3	6.1	13.3	13.3
Earthing system (e.g. 1/N/PE)		1/N/PE	1/N/PE	1/N/PE	1/N/PE	1/N/PE	1/N/PE
Power line frequency	Hz	50/60			50/60		
Power line voltage +/- 10 %	V	230	230		230	230	
IP protection system		IP 20			IP 20		
Protection class		I			I		
Overvoltage category as per IEC 60364-4-443		II			II		
Device fusing, building side	A	16			16		
Device fusing, on PCB	A	2 x 16			2 x 16		
Environmental conditions							
Min. ambient temperature	°C/°F	18/65			18/65		
Max. ambient temperature	°C/°F	32/90			32/90		
Max. humidity in service, non condensing	% r.F./% r.H.	80, non condensing			80, non condensing		
Min. storage temperature	°C/°F	20/68			20/68		
Max. storage temperature	°C/°F	60/140			60/140		
Max. humidity in storage, non condensing	% r.F./% r.H.	90, non condensing			90, non condensing		
Post-transport acclimation time	h	2			2		
Noise level	dB(A)	45	52	52	45	52	52
Degree of pollution as per IEC EN 61010-1		2			2		

Table 13-2 Technical Data - OMH-S and OMH Series

Parameter	Unit	OMH 60	OMH 100	OMH180	OMH 60-S	OMH 100-S	OMH 180-S
Site conditions							
Maximum altitude above sea level	m/y ASL	2000/2187			2000/2187		
Minimum side clearance	mm/in	50/2			50/2		
Minimum front clearance	mm/in	590	690	814	590	690	814
Minimum back wall clearance	mm/in	80/3.2			80/3.2		
Minimum bottom clearance	mm/in	200/8			200/8		
Minimum top clearance	mm/in	300/12			300/12		

¹ Temperatures as low as ambient +10 °C can be selected, this requires open damper and no additional heat in unit.

Table 13-3 Technical Data - OMH Series

Parameter	Unit	OMH 400	OMH 750	OMH 750-3P
Process				
Work Space Atmosphere Min. ¹	°C/°F	50 °C/122 °F	50 °C/122 °F	50 °C/122 °F
Max.	°C/°F	250 °C/482 °F	250 °C/482 °F	300 °C/572 °F
Temperature deviation from set value at 150 °C (302 °F), spatial. Max. value/Typical value.	K	±2.5 /±2.1	±3.5/±3.1	±3.5/±3.1
Temperature deviation from set value at 150 °C (302 °F), over time.	K	±0.4/±0.3	±0.5/±0.4	±0.5/±0.4
Heat-up time (work space unoccupied, from 25 °C (77 °F) to 98% of set temperature of 150 °C/302 °F) Max. value/Typical value	min	35	50	50
Recovery time (work space unoccupied, door open for 30 s, to set temperature). Max. value/Typical value.	min	< 7 / < 5	< 12 / < 10	< 12 / < 10
Heat dissipation to environment (at set temperature of 150 °C (302 °F) and room temperature of 25 °C/77 °F)	W	630 ±10%	990 ±10%	990 ±10%
Max. air change at 150 °C (302 °F)	h ⁻¹	23	17	17
Overall dimensions				
Height (with casters)	mm/in	1655/ 65.2		
Width	mm/in	755/ 29.7	1215/ 47.8	
Depth	mm/in	770/ 30.3		
Overall weight	kg/lbs	135/298	185/408	185/408

Table 13-3 Technical Data - OMH Series

Parameter	Unit	OMH 400	OMH 750	OMH 750-3P
Loading capacity per shelf	kg/lbs	40/88		
Max. overall loading capacity per device	kg/lbs	75/165	150/330	
Electrical Data				
Power rating	W	3000	3000	5750
Maximum current	A	10.5	13.0	12.0
Earthing system (e. g. 1/N/PE)		1/N/PE	1/N/PE	3/N/PE
Power line frequency	Hz	50/60		
Power line voltage +/- 10 %	V	230		400
IP protection system		IP 20		
Protection class		I		
Overvoltage category as per IEC 60364-4-443		II		
Device fusing, building side	A	16		3 x 16
Device fusing, on PCB	A	2 x 16		3 x 16
Environmental conditions				
Min. ambient temperature	°C/°F	18/65		
Max. ambient temperature	°C/°F	32/90		
Max. humidity in service, non condensing	% r.F./ % r.H.	80, non condensing		
Min. storage temperature	°C/°F	20/68		
Max. storage temperature	°C/°F	60/140		
Max. humidity in storage, non condensing	% r.F./ % r.H.	90, non condensing		
Post-transport acclimation time	h	2		
Noise level	dB(A)	no inherent noise		
Degree of pollution as per IEC EN 61010-1		2		
Site conditions				
Maximum altitude above sea level	m/y ASL	2000/2187		
Minimum side clearance	mm/in	120/4.7		
Minimum front clearance	mm/in	810 /31.9	670 / 26.4	
Minimum back wall clearance	mm/in	120/5.9		
Minimum top clearance	mm/in	200/8		

¹ Temperatures as low as ambient +10 °C can be selected, this requires open damper and no additional heat in unit.

Spare Parts and Accessories

Material No.	Description
50027662	Fresh air filter for Heratherm ovens
50073715	Fuses 5,0 A 250V T 6, 3 X 32 mm
50126665	Stacking adapter Heratherm 60L
50126666	Stacking adapter heratherm 100L
50126667	Stacking adapter heratherm 180L
50127102	Kit fresh air filter for Heratherm ovens
50127431	Outer door for Heratherm IGS 60, IMH 60, IMH 60-S, OMS 60, OMH 60, OMH 60-S, OGS 60, OGH 60 und OGH 60-S with a door stop on the left side
50127432	Outer door for Heratherm IGS 100, IMH 100, IMH 100-S, OMS 100, OMH 100, OMH 100-S, OGS 100, OGH 100 und OGH 100-S with a door stop on the left side
50127433	Outer door for Heratherm IGS 180, IMH 180, IMH 180-S, OMS 180, OMH 180, OMH 180-S, OGS 180, OGH 180 und OGH 180-S with a door stop on the left side
50127434	Outer door for Heratherm IGS 60, IMH 60, IMH 60-S, OMS 60, OMH 60, OMH 60-S, OGS 60, OGH 60 und OGH 60-S with a door stop on the right side
50127435	Staple feet Heratherm incubators and heating & drying ovens
50127436	Kit door seal for Heratherm 60L
50127437	Kit door seal for Heratherm 100L
50127438	Kit door seal for Heratherm 180L
50127439	Kit door clips for Heratherm 60L / 100L / 180 L
50127443	Levelling feet for Heratherm incubators and heating & drying ovens
50127444	Kit door handle right Heratherm incubators and heating & drying ovens
50127445	Kit door handle left Heratherm incubators and heating & drying ovens
50127446	Kit door handle right Heratherm incubators and heating & drying ovens

Material No.	Description
50127447	Kit door handle left Heratherm incubators and heating & drying ovens
50127448	Temperature sensor for Heratherm heating & drying ovens
50127450	Upper door hinge for Heratherm incubators and heating & drying ovens
50127451	Lower door hinge for Heratherm incubators and heating & drying ovens
50127455	Outer door for Heratherm IGS 100, IMH 100, IMH 100-S, OMS 100, OMH 100, OMH 100-S, OGS 100, OGH 100 und OGH 100-S with a door stop on the right side
50127456	Outer door for Heratherm IGS 180, IMH 180, IMH 180-S, OMS 180, OMH 180, OMH 180-S, OGS 180, OGH 180 und OGH 180-S with a door stop on the right side
50127458	Kit operating panel Heratherm Advanced Protocol and Advanced Protocol Security incubators and heating & drying ovens
50127462	Kit electronic insert Heratherm Advanced Protocol and Advanced Protocol Security incubators and heating & drying ovens without main board fan
50127463	Mainboard cable for Heratherm incubators and heating & drying ovens
50127469	Door switch for the right side of Heratherm incubators and heating & drying ovens
50127470	Door switch for the left side of Heratherm incubators and heating & drying oven
50127477	Temperatur limiter for OMH, OMH-S, OGH, OGH-S
50127480	Door hook catch for Heratherm incubators and heating & drying ovens with a door stop on the right side
50127481	Door hook catch for Heratherm incubators and heating & drying ovens with a door stop on the left side
50127482	Magnetic door hook catch for Heratherm incubators and heating & drying ovens with a door stop on the right side
50127483	Magnetic door hook catch for Heratherm incubators and heating & drying ovens with a door stop on the left side
50127499	Heating coils for Heratherm OGS 60, OGH 60, OGH 60-S at a voltage of 120 V
50127500	Heating coils for Heratherm OGS 60, OGH 60, OGH 60-S at a voltage of 230 V
50127502	Heating coils for Heratherm OGS 100, OGH 100, OGH 100-S at a voltage between 208 and 240 V
50127503	Heating coils for Heratherm OGS 180, OGH 180, OGH 180-S at a voltage between 208 and 240 V

Material No.	Description
50127504	Heating coils for Heratherm OMS 60, OMH 60, OMH 60-S at a voltage of 120 V
50127509	Kit fan system Heratherm OMS 60, 120 V
50127510	Kit fan system Heratherm OMS 100 and OMS 180, 208-240 V
50127511	Kit fan system Heratherm IMH 60 IMH 60-S, OMH 60 and OMH 60-S, IMH 100, IMH 100-S, IMH 180 and OMH 180-S, 120 V
50127512	Kit fan system Heratherm OMH 100, OMH 100 , IMH 180, IMH 100-S and OMH 180, 208-240 V
50127513	Kit fan system Heratherm OMS 60, 230 V
50127514	Kit fan system Heratherm OMS 100 and OMS 180, 230 V
50127515	Heating coils for Heratherm OMS 60, OMH 60, OMH 60-S at a voltage of 230 V
50127519	Heating coils for Heratherm OMS 100, OMH 100, OMH 100-S, OMS 180, OMH 180, OMH 180-S at a voltage between 208 and 240 V
50127532	Circulation fan OMH / OMH-S D = 180 mm (7.1 inch), H = 28 mm (1.1 inch)
50127544	Door window seal for Heratherm heating and drying ovens
50127555	Kit fan system Heratherm IMH 60, IMH 60-S, OMH 60 and OMH 60-S, IMH 100, IMH 100-S, IMH 180 and OMH 180-S, 230 V
50127556	Kit fan system Heratherm OMH 100, OMH 100-S, IMH 180, IMH 100-S and OMH 180, 230 V
50127557	Mechanical air inlet slider for Heratherm OMS 60 and OGS 60
50127558	Mechanical air inlet slider for Heratherm OMS 100, OGS 100, OMS 180 and OGS 180
50127559	Kit electrical air flap Heratherm Advanced Protocol and Advanced Protocol Security ovens
50127566	Fresh air filter for OMH, OGH, OMH-S, OGH-S
50127662	Fresh air filter OGH / OGH-S / OMH / OMH-S
50127741	Support stand with castors for Heratherm 60L
50127742	Support stand with castors for Heratherm 100L
50127743	Support stand with castors for Heratherm 180L
50127761	Wire mesh shelf OGS 60 / OGH 60 / OGH-S 60, including 2 shelf supports
50127762	Wire mesh shelf OGS 100 / OGH 100 / OGH-S 100, including 2 shelf supports
50127763	Wire mesh shelf OGS 180 / OGH 180 / OGH-S 180, including 2 shelf supports

Material No.	Description
50127764	Wire mesh shelf OMS 60/100/180 / OMH 60/100/180 / OMH 60/100/180-S, including 2 shelf supports
50127765	Wire mesh shelf OMS 100 / OMH 100 / OMH 100-S, including 2 shelf supports
50127766	Wire mesh shelf OMS 180 / OMH 180 / OMH 180-S, including 2 shelf supports
50127767	Sample sensor for OGH 60-S, OGH 100-S, OGH 180-S, OMH 60-S, OMH 100-S, OMH 180-S
50127773	Stainless steel perforated shelf IMH 60 / IMH 60-S / OMH 60 / OMH 60-S/OMS 60/100/180, including 2 shelf supports
50127774	Stainless steel perforated shelf IMH 100 / IMH 100-S / OMH 100 / OMH 100-S/OMS 60/100/180, including 2 shelf supports
50127777	Stainless steel perforated shelf IMH 180 / IMH 180-S / OMH 180 / OMH 180-S/OMS 60/100/180, including 2 shelf supports
50127861	Retaining spring for Heratherm incubators and ovens
50127862	Support rail for Heratherm IGS 60, IMH 60, IMH 60-S, OMS 60, OMH 60, OMH 60-S
50127863	Support rail for Heratherm IGS 100, IMH 100, IMH 100-S, OMS 100, OMH 100, OMH 100-S
50127864	Support rail for Heratherm IGS 180, IMH 180, IMH 180-S, OMS 180, OMH 180, OMH 180-S
50127914	Stainless steel perforated shelf for OGS 60 / OGH 60 / OGH 60-S, including 2 shelf supports
50127925	Stainless steel perforated shelf for OGS 100 / OGH 100 / OGH 100-S, including 2 shelf supports
50127926	Stainless steel perforated shelf for OGS 180 / OGH 180 / OGH 180-S, including 2 shelf supports
50128182	Main board cooling fan Heratherm Advanced Protocol and Advanced Protocol Security heating & drying ovens
50128184	Sample sensor connection for Heratherm incubators and heating & drying ovens
50128186	Kit window bulbs Heratherm heating & drying ovens
50128237	Kit Key for door handle with lock Heratherm
50128880	Reinforced wire mesh shelf OGS 180 / OGH 180 / OGH 180-S
50128881	Reinforced wire mesh shelf OMS 180 / OMH 180 / OMH 180-S
50128887	Kit hot air flexible tube for Heratherm built-in units
50130347	Fibre glass pads Ø 20 mm (0.8 inch)
50130348	Fibre glass pads Ø 50 mm (2 inch)
50130657	Kit Viton door seal 60 L Heratherm

Material No.	Description
50130658	Kit Viton door seal 100 L Heratherm
50130659	Kit Viton door seal 180 L Heratherm
50134094	Kit heating coil OGS 750, 230 V
50134115	Kit heating coil OGS 400, 750, 230 V
50134118	Kit heating coil OMH 750, 230 V
50134119	Kit heating coil OMH 750, 3 Ph, N
50134124	Kit heating coil OGS 750, 3 Ph
50134125	Kit heating coil OGS 750, 3 Ph
50134315	Kit DS bus cable cpl 400 / 750
50134326	Door gasket 400 L HTM
50134327	Door gasket 750 L HTM
50134328	Kit profile gasket 750 L HTM
50134329	Kit door conn. clips 400 / 750 HTM
50134333	Kit castors 400 / 750 HTM
50134334	Kit shelf rack set cpl HTM 400 / 750
50135043	Kit electric insert cpl HTM H floorstand
50135044	Kit electric insert cpl HTM S floorstand
50135055	Kit electric insert cpl HTM 3 PH floor
50135058	Kit door lock 750 left cpl HTM
50135059	Kit door lock 750 right cpl HTM
50135060	Door outer casing left HTM 400
50135061	Door outer casing right HTM 400
50135062	Door outer casing left HTM 750
50135063	Door outer casing right HTM 750
50135151	Kit temperature sensor cpl HTM ovens floor
50135152	Kit overtemperature cut-off HTM ovens 350 floor
50135153	Kit door lock 400 right cpl HTM
50135154	Kit door lock 400 left cpl HTM

Contact

Overview of Thermo Fisher International Sales Organization

Postal address in Germany

Thermo Electron LED GmbH
Robert-Bosch-Straße 1
D - 63505 Langenselbold

Enquiries from Germany:

Phone

Sales 0800 1 536376

Service 0800 1 112110

Fax

Sales/Service 0800 1 112114

E-Mail info.labequipment.de@thermofisher.com

Enquiries from Europe, Middle East and Africa:

Phone. + 49 (0) 6184 / 90-6940

Fax + 49 (0) 6184 / 90-6772

Email info.labequipment.de@thermofisher.com

Postal address USA:

Thermo Scientific
275 Aiken Road
Asheville, NC 28804
USA

Enquiries from North America:

Phone +1 800-879 7767

Fax +1 828-658 0363

Email info.labequipment@thermofisher.com

Enquiries from Latin America:

Phone +1 828-658 2711

Fax +1 828-645 9466

E-Mail info.labequipment@thermofisher.com

Enquiries from Asia Pacific:

Phone +852-2711 3910

Fax +852-2711 3858

Email info.labequipment@thermofisher.com

Thermo Fisher Scientific, Inc.
81 Wyman Street
P.O. Box 9046
Waltham, MA 02454-9046
United States

www.thermo.com