

pipetman®

M96

User Guide

EN



 **GILSON®**

TABLE OF CONTENTS

INTRODUCTION | 3

DESCRIPTION | 3









- Part Checklist | 4
- Good Laboratory Practice (GLP) Compliance | 4
- Accessories Recommended for Optimal Usage | 5
- Specifications | 9

SAFETY PRECAUTIONS AND LIMITATIONS OF USE | 10

GENERAL OPERATIONS | 10

- Getting Started | 10
- General Parameters and Pipetting Option | 11
- Fitting and Ejecting the Tips | 13
- Pipetting | 15

PIPETTING MODES AND APPLICATIONS | 18

-  Pipette | 19
-  Reverse | 20
-  Mix | 20
-  Repetitive | 20
-  Serial Dilution Using the Multi-Tray | 21
-  Plate-To-Plate | 22
-  Manual Pipetting | 24
-  Custom | 25

CLEANING | 27

TROUBLESHOOTING | 28

MAINTENANCE AND SPARE PARTS | 29

- Leak Test | 29
- Use of Lubrication Box | 29
- Spare Parts | 29

SOFTWARE AND CONNECTION | 30

- PIPETMAN® M96 Software | 30

REGULATORY COMPLIANCE | 31

WARRANTY | 31

APPENDICES | 32

- Appendix A - Example of a Performance Check | 32
- Appendix B - Z Factor | 33
- Appendix C - Evaporation Loss | 34
- Appendix D - Glossary | 34

NOTES | 35



Chapter 1

INTRODUCTION

PIPETMAN® M96 is a convenient and intuitive air displacement electronic pipette for high-throughput pipetting on 96- and 384-well microplates. It is part of the PIPEMAN® M range, combining its renowned accuracy and precision with user-friendly functions for increased efficiency and fast microplate filling.

PIPETMAN M96 offers advanced ergonomics, a large touchscreen to assist the user through different pipetting functions and steps, and accessories to handle and stack various microplates in a limited working space.

Increase the productivity of your workflow with the all-in-one, simple, and intuitive PIPETMAN M96:

- **Simple and flexible:** intuitive and fully assisted screen for various applications; programmable to confidently create and handle your workflows.
- **Convenient:** fully transportable for working on benches or under fume hoods, used with standard PIPETMAN® DIAMOND Tips, and compatible with a large variety of SLAS-standard labware.
- **Ready-to-use pipette:** no setup is required with the integrated screen, and the main accessories are already installed.

PIPETMAN M96 is available in four different models, covering a total volume range from 2 µL to 200 µL.

PIPETMAN® M96			
Model	Part Number	Volume Range	
		Standard Pipette Mode	Repetitive Mode
P96x20M, with Bluetooth® Connection	FH10001	2-20 µL	1-20 µL
P96x200M, with Bluetooth® Connection	FH10002	10-200 µL	5-200 µL
P96x20M	FH10003	2-20 µL	1-20 µL
P96x200M	FH10004	10-200 µL	5-200 µL

NOTE

PIPETMAN M96 Bluetooth-connected models are available in select locations. Please contact your Gilson representative for more details.

Chapter 2

DESCRIPTION

PIPETMAN M96 is a compact, electronic 96-channel pipette equipped with accessories for optimal use with various SLAS-size microplates and labware.

Some accessories are included in the box ●, and other accessories are sold separately ●. Refer to the information below and [Accessories Recommended for Optimal Usage](#) for more details.

NOTE

When it is unpacked, PIPETMAN M96 is ready to use. Accessories are already in place; no special handling is required to install the pipette.



Figure 1

PIPETMAN® M96 accessories description



Part Checklist

Each box of PIPETMAN M96 contains a pipette, accessories, a sample of tips, and documents.
After unpacking the pipette, verify that the following items are included:



PIPETMAN M96 Part Checklist	
Part Description	Part Number (Available as Accessory)
A PIPETMAN M96 pipette	
B Rotating reversible tray 96-96 well sides	FH07002
C Single reversible tray 96-384 well sides	FH07001
D Adapter for PIPETMAN DIAMOND Tips Reload Pack and Blister Refill (PIPETMAX® Tip Reload Block)	32000175
E PIPETMAN DIAMOND Tips Blister Refill 384-certified DS200 autoclavable - 2 Blister Refills	F172310 (Box of 10 Blister Refills)
F Nalgene™ disposable polypropylene reservoir, flat bottom non-sterile - 2 units	
Adhesive bumpers for the rotating tray - 2 units	
Power supply with power cord	Refer to Spare Parts
USB-C cable	
Quick guide	
Handling requirements leaflet	
Certificate of conformity (including barcode sticker)	

NOTE The PIPETMAN M96 box includes two reservoirs for immediate handling of the pipette as soon as it is unpacked. These reservoirs are not available separately nor sold as extra accessories.

Figure 2
PIPETMAN® M96 part checklist

Good Laboratory Practice (GLP) Compliance

Pipette Identification

Each PIPETMAN M96 is identified with a resistant label indicating product designation, part number, and serial number with their associated barcodes. The same label is stuck on the box of the pipette for logistics and traceability purposes. A certificate of conformity is included in each box, for a complete traceability of your pipette.

The serial number is also displayed on the screen of the pipette (refer to [Device Info and User Guide](#)). It provides unique identification of your pipette and the date of manufacture.

Example: **A** **B** **15500**
Year Month Production number

Admin Control

PIPETMAN M96 features an Admin control function to comply with most of the Standard Operating Procedures. Some custom protocols and parameters can be locked and unlocked with a PIN code (refer to [Device Config](#) for further details).

Service Information

To better monitor the maintenance of PIPETMAN M96, both users and Gilson Service representatives can plan the next service date according to different parameters (refer to [Service Info](#) for further details).

Accessories Recommended for Optimal Usage

The following accessories are recommended for an enhanced use of the PIPETMAN M96, to store more microplates, and to work on specific applications such as plate-to-plate transfer or serial dilutions.

Several SLAS-standard microplates can be stacked on the different trays to save space and gain efficiency.

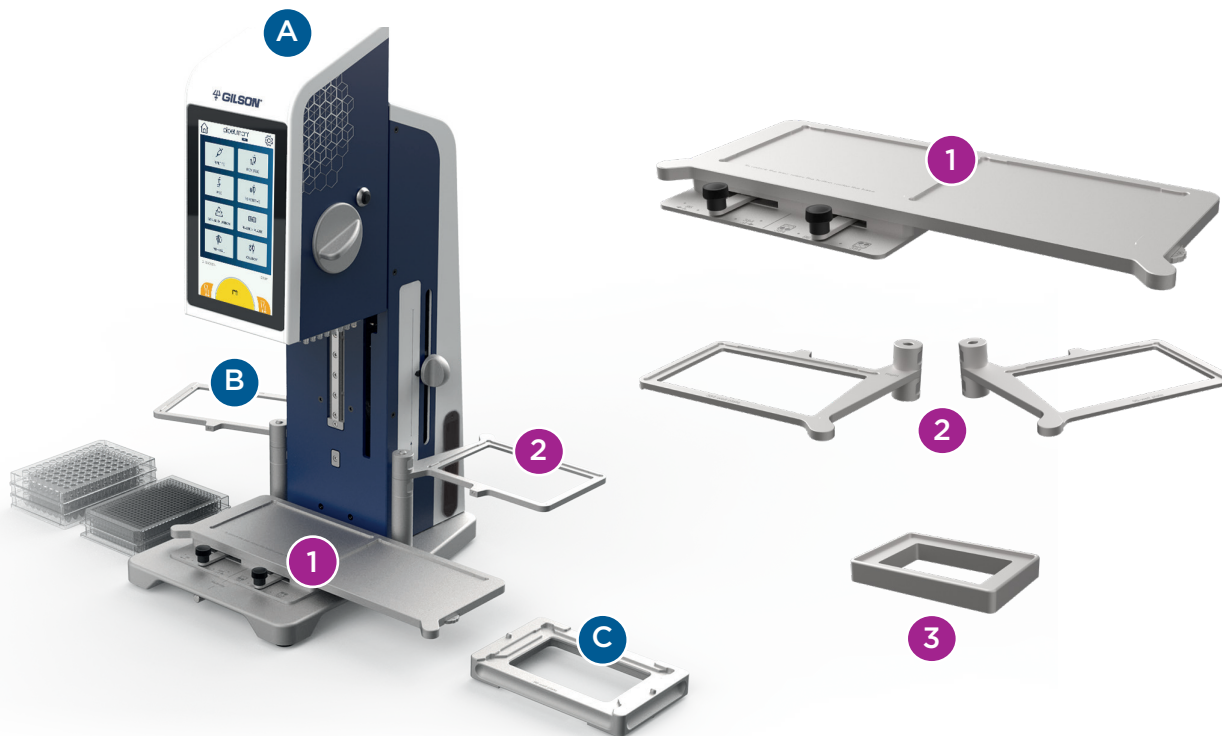

PIPETMAN® M96 Recommended Accessories

Part Description	Part Number
1 Multi-tray for 96- and 384-well microplates	FH07005
2 Rotating reversible tray 96 well left side - 384 well right side	FH07004
2 Rotating reversible tray 384-384 well sides	FH07003
3 Adapter for PIPETMAN® DIAMOND Tips TIPACK™	FH07006
A PIPETMAN M96 pipette	
B Rotating reversible tray 96-96 well sides (provided with the pipette, and available as an extra accessory)	FH07002
C Single reversible tray 96-384 well sides (provided with the pipette, and available as an extra accessory)	FH07001

● Included in the PIPETMAN M96 box | ● Sold separately

NOTE

All accessories comply with the SLAS standards and can be used with any microplate or adapter for microplates meeting these standards. Each side of the reversible tray specifies the kind of microplate that can be placed on it (96 or 384).

Dimensions of the 384-well microplate tray are larger than the size of 384-well microplates to allow the user to move the microplate from one corner to another to fill a 384-well plate in only four steps with 96 tips.

Multi-tray locations for microplates are designed to fit any SLAS-standard plate. The tray has shifting levers and can be moved sideways and back and forth.

Single tray and multi-tray both fit on the base of the pipette: one can be replaced with the other one, but both trays cannot be fitted together.

Figure 3

PIPETMAN® M96 recommended accessories





Rotating Trays

Three rotating tray models are proposed to meet various needs and microplate handlings. They are reversible and can be fitted on the left or right side of the PIPETMAN M96.

Choose the reversible rotating tray according to your needs (sides of the trays are adapted to 96- or 384-well microplates).

To equip PIPETMAN M96 with a reversible rotating tray, fit the tray's hinge on the adapted tray holder rod on each side of the pipette.

NOTE

When pipetting, rotating trays will remain in place under the pipetting head because of a small magnetic fixing system on the pipette's body.

Trays can be placed one above the other under the pipetting head to store the pipette and save space.

Adhesive bumpers can be stuck on the rotating trays or on the side of the pipette to prevent shocks if the rotating trays are forcefully turned.

Single Reversible Tray 96-384 Well Sides

This tray is reversible, with one side adapted to 96-well microplates and one side adapted to fill a 384-well plate in only four steps with 96 tips.

To fit the single tray :

1. Put it in the indicated location on the base of the pipette.
2. Place the two small spheres, which are on the small sides of the tray inside the corresponding holes on the base of the pipette.
3. Lift the tray from the base to remove it.



Figure 4
PIPETMAN® M96 single tray

To place a microplate or tips with adapters on the 96-well microplate location, slide the labware or the adapter from the front to the back of the tray.

NOTE

After dispensing liquid into the microplates, slightly lift the pipetting head to have the end of the tips close to the top of the microplate wells. The microplate can be delicately slid to the front to be in contact with the tips and remove the liquid remaining on the wall of the wells.

Multi-Tray for 96- and 384-well Microplates

This tray is a convenient accessory to perform various pipetting applications such as serial dilutions or plate-to-plate transfer, sliding from one plate to the other.

PLACING AND REMOVING THE MULTI-TRAY FROM THE PIPETTE

To fit the multi-tray, put it in the indicated location on the base of the pipette. Place the pin, which is under the multi-tray center, inside the corresponding hole on the base of the pipette. It is now locked on the base of the pipette for convenient usage without any risk of wrong movement during pipetting.

To unlock the multi-tray:

- 1 Press the button under the base
- 2 By pressing the button, gently lift the tray and remove it from the base of the pipette (refer to Figure 5)



NOTICE

When installed on the pipette, the multi-tray is locked and must not be lifted or removed without pressing the unlocking button under the base. Do not force tray removal; it could damage both the pipette and the accessory.

MOVING THE MULTI-TRAY WHEN PIPETTING

The multi-tray is equipped with two positioning wheels and shifting levers (refer to Figure 5).

Positioning wheels

The positioning wheels allow precise placement of the microplates under the pipetting head depending on their type, either 96- or 384-well. When the microplate or the tips are placed under the pipetting head, turn the wheel and select the kind of plates (96- or 384-well) according to your needs.

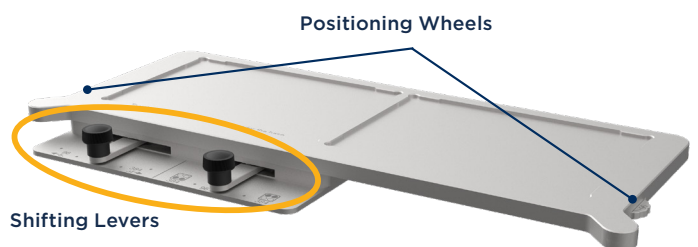

Figure 5
Placing and removing the PIPETMAN® M96 multi-tray



Shifting levers

One shifting lever (refer to Figure 5) enables the back-and-forth movement of the 384-well microplate, and the other one enables the user to set the preferred option when moving the tray sideways – free sliding or with notches.

1 Manually move the tray sideways

Position A of the shifting lever: free slide of the tray without any pre-set position

Position B: pre-set positions – slide the tray from one column to the other via a slight notch. Notches are adapted to the column widths of different microplate formats (96- or 384-well).

- Moving the shifting lever **to the left** will allow it to slide from one 96-well plate column to the next one.
- Moving the shifting lever **to the right** will allow it to slide from one 384-well plate column to the next one.

Position C: same as position B with a more significant notch.

- ### 2 Use the back-and-forth lever to move the tray
- and the 384-well plate from one line to another. The use of the two shifting levers allows the user to fill a 384-well plate in only four steps with 96 tips (refer to [Pipetting in 384-well Microplates](#) for further details).

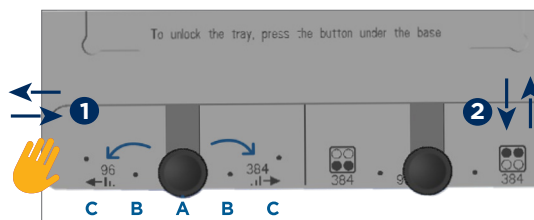

PIPETMAX and PLATEMASTER Accessories Compatible with PIPETMAN M96

Model	Part Number
PIPETMAX tips disposal bin	32000274
3D printed rack for semi-skirted or non-skirted PCR plates	3D0006
Adapter for 384 PCR plate	3D0003
Gilson metal rack for semi or non-skirted PCR plates	32000196
Alu-heater block for PLATEMASTER, 96x0.2 mL, for PCR tubes, strips & PCR plates diam. 7.8mm	F1077604

Main Features Description



Features	
A	Intuitive touchscreen with integrated pipetting touch button and ejection buttons for left- or right-handed users
B	Adjustable finger rest – can move around an axis for optimal comfort and ergonomics
C	Pipetting buttons – can be used instead of the central touchscreen button: freedom of choice for a preferred way of pipetting
D	Pin-plate (96-channel tip holder) near a white light illuminating the tips and microplates
E	Tip-fitting arm
F	Height-fixing screw – to define the lowest possible pipetting height and prevent touching accidentally the bottom of the microplate wells Preferred height can be personalized and marked with dry-erase markers on the whiteboard sticker
G	Rotating tray holder
H	Head locking bar – recommended to move the pipette from one place to another
I	Transport handle
J	Switch (I/O), DC input for main adapter and USB-C port

NOTE

The light of the pipetting head can be turned off when working with specific light-sensitive reagents or samples.

Figure 6
PIPETMAN® M96 main features description



Intuitive Touchscreen

The display includes information and tactile areas for quick and easy handling of the pipette right from the first use.

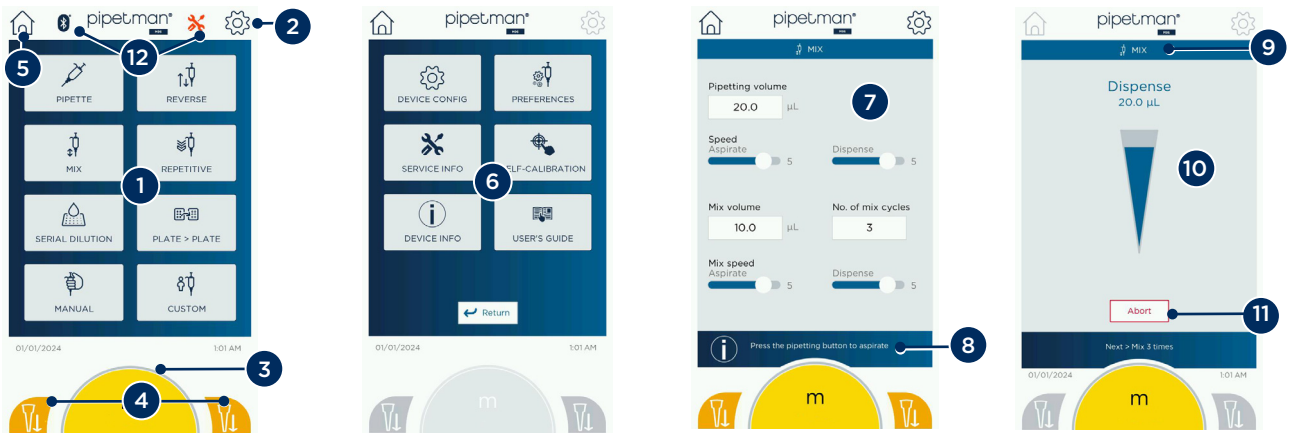

Features	
1	Main menu with touch icons to start a pipetting mode – refer to Pipetting for more details
2	General Parameters icon: touch the icon and reach the General Parameters screen
3	Touch pipetting button
4	Ejection buttons for left- or right-handed users
5	Home icon: touch the icon and reach the Home page with the main menu
6	General Parameters menu with touch icons – refer to General Parameters and Pipetting Options for more details
7	Pipetting Parameters, displayed to be set before starting pipetting (adapted to each pipetting function) – refer to PIPETTING MODES AND APPLICATIONS for more details
8	The Contextual Help Bar assists the user at each step of the protocol. Pressing on the i icon will provide further assistance or explanations on the current pipetting mode
9	Information on the current pipetting mode
10	On-time pipetting information, with the on-time level of liquids remaining in the tips The dark blue bar above the pipetting button indicates the next step
11	Abort button, to push whenever a protocol must be stopped or canceled – refer to Pipetting for more details
12	When Bluetooth® is enabled (for Bluetooth-connected models only), a Bluetooth logo will appear on the screen When service is overdue, a reminder service icon will appear on the screen

NOTE For PIPETMAN M96 Bluetooth-connected models, Bluetooth can be turned on and off from the [Device Config](#) page. When enabled, the Bluetooth logo will appear on the top bar of the screen as indicated in the table above.

The next service date can be set in the General Parameters (refer to [General Parameters and Pipetting Option](#) for more details).

Transporting PIPETMAN M96

PIPETMAN M96 is a compact 96-channel electronic pipette that can be placed on any bench or under fume hoods depending on the applications and needs.

To carry the pipette and move it from one place to another:

- 1 Align the top of the head with the top of the pipette.
- 2 Lock the pipetting head by sliding the head locking bar towards the padlock logo.
- 3 Use one hand to carry PIPETMAN M96 with the transport handle and the other hand to firmly hold the base of the pipette.

To start pipetting, unlock the pipetting head by sliding the head locking system to the left.

NOTICE Never move the pipette without locking the pipetting head. Damage caused by movement of the pipetting head without locking the device will not be covered by the warranty.

CAUTION Watch out for the pinch when moving the different elements.

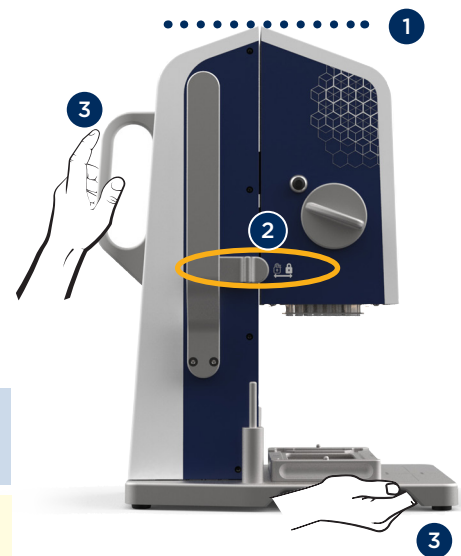

Specifications

Technical Data

	P96x20M	P96x200M
Part Numbers	FH10001 (Bluetooth-connected) FH10003	FH10002 (Bluetooth-connected) FH10004
Dimensions (Pipetting Head in the Locked Position)	340 x 210 x 450 mm (W x L x H)	
Weight (Without Accessories)	Approx. 10.2 kg	
Labware Compatibility	Standard SLAS microplates	
External Power Supply	Voltage Input Frequency: 47 to 63 Hz Voltage: 90-264V AC Voltage Output Voltage: 24V DC (Direct Current) Current Rating: 3.75A, 90W	
Environmental Conditions	Degree of pollution : indoor use level 2 Altitude: up to 2000 m Temperature range: 5°C to 40°C Humidity: maximum relative humidity 80%	
Storage Conditions	Temperature: -20°C to 50°C - Humidity max: 80%	
Main Materials	Housing: polystyrene (PS) Pin Plate: Polyoxymethylene (POM), Stainless Steel Metal parts (tip fitting arm, base, trays, etc.): Aluminum	
Bluetooth Specifications (For Bluetooth-Connected Models Only)	Frequency Band: 2400–2483.5 MHz Power Output: 8 dBm	
Degree of Ingress Protection (IEC 60529)	IP20	

Gilson Maximum Permissible Errors

PIPETMAN M96 is a high-quality pipette that offers excellent accuracy and precision. The figures given below in Table 1 Gilson Maximum Permissible Errors were obtained using PIPETMAN DIAMOND Tips, at the factory-set speeds (6/6 for P96x20M and 3/6 for P96x200M).

These values are guaranteed only when genuine PIPETMAN DIAMOND Tips are used.

Each pipette is inspected and validated by qualified technicians in accordance with the Gilson Quality System. Gilson declares that its manufactured pipettes comply with the requirements of the ISO 8655 standard by type testing.

The adjustment is carried out under strictly defined and monitored conditions (ISO 8655-6).

Table 1

PIPETMAN® M 96 maximum permissible errors

PIPETMAN® M96								
Model	PIPETMAN® DIAMOND Tips	Volume Range (µL)	Volume Test Control		GILSON			
			(µL)	(%)	Systematic Error (µL)	Random Error (µL)	Systematic Error (%)	Random Error (CV)*
P96x20M	D200	2-20	2	10	± 0.12	≤ 0.100	± 6.00	≤ 5.0
			10	50	± 0.12	≤ 0.100	± 1.20	≤ 1.0
			20	100	± 0.20	≤ 0.180	± 1.00	≤ 0.9
P96x200M	D200	10-200	20	10	± 0.4	≤ 0.2	± 2.00	≤ 1.25
			100	50	± 1.00	≤ 0.60	± 1.00	≤ 0.60
			200	100	± 1.60	≤ 0.80	± 0.80	≤ 0.40

*CV means Coefficient of Variation (%)



SAFETY PRECAUTIONS AND LIMITATIONS OF USE

For safety reasons, it is important to observe the following instructions:

- Use PIPETMAN M96 and its AC adapter indoors.
- **When pipetting infectious, radioactive, toxic, and other hazardous solutions**, please observe all the safety precautions (e.g., wear protective clothing, goggles, and gloves) and regulations appropriate for your country.

CAUTION

Watch out for the pinch when moving the different elements.

Pipetting corrosive liquids may damage PIPETMAN M96 parts in contact with the solution. In case of contact with aggressive liquids, immediately clean up parts in contact. To protect the inside parts of PIPETMAN M96 when pipetting corrosive or volatile liquids, the use of filter tips is highly recommended.

Pipetting of extremely viscous or highly evaporating liquids is at your own risk. The same applies to aggressive and corrosive reagents.

Avoid aspiration of any liquid into the pin-plate.

Chapter 4

GENERAL OPERATIONS

Getting Started

To start PIPETMAN M96:

- 1 Make sure that PIPETMAN M96 is connected to the external power supply and that the external power supply is connected to a power source, and then turn the power switch on.
- 2 The screen and the light in front of the pin-plate will light up.
- 3 An animation explaining how to fit tips appears on the screen during initialization (it lasts a few seconds only). Touch the screen to skip the animation and reach directly the home screen.
- 4 When the pipette is ready, the home screen will automatically appear.

To switch off PIPETMAN M96, press the power switch to the 0 position.



General Parameters and Pipetting Options

1. Touch the Parameters icon  to reach the different settings options and pipette parameters.
2. Then, touch the screen to reach the requested menu: **DEVICE CONFIGURATION, PIPETTING PREFERENCES, SERVICE INFO, SELF-CALIBRATION, DEVICE INFO, or USER GUIDE.**
3. Touch the Return button to go back to the Home page.

DEVICE CONFIG

- Select the **sound parameters** according to your preferences.
- Set the **time and date** according to your preferences.
- Control the **light** and the **brightness** of the screen
- Enable **Admin control**: create an Admin PIN to secure some protocols and service information.
- Enable the **screen saver** and define its parameters: when activated, the screen switches off after the defined timeout. A simple touch on the screen will turn it on back to where it was before switching off.
- Enable the **Bluetooth** (for PIPETMAN M96 Bluetooth-connected versions only).

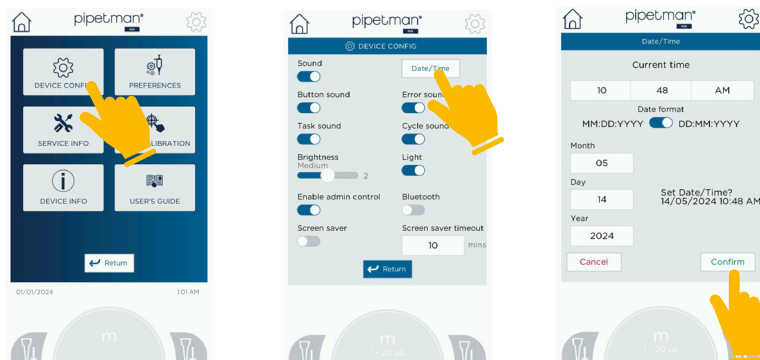

The light of the pipetting head can be turned off when working with specific light-sensitive reagents or samples.

When creating an Admin PIN code, save it somewhere as an extra safety: in case of a forgotten PIN code, PIPETMAN M96 will not recall it.

NOTICE

The defined time and date will be indicated below the Contextual Help Bar during pipetting.

For PIPETMAN M96 Bluetooth-connected models, Bluetooth can be turned on and off from the [Device Config](#) page. When enabled, the Bluetooth logo will appear on the top bar of the screen as indicated in the table above.

PIPETTING PREFERENCES (PREFS)

This menu defines the pipetting preferences when PIPETMAN M96 is operating. Preferences will remain the same for each pipetting function and can be changed when the pipette is not operating. If Auto options are not selected, mix, purge, and blow-in will be activated with a touch on the pipetting button during pipetting.

- **Auto mix**: select the button for an automatic mix after pipetting (refer to [PIPETTING MODES AND APPLICATIONS](#), part Mix for further details).
- **Auto purge**: select the button for an automatic purge after each pipetting step.
- **Auto blow-in**: select the button for an automatic blow-in after each pipetting step. Define the blow-in delay to allow time to remove the tips from the liquid before the blow-in.

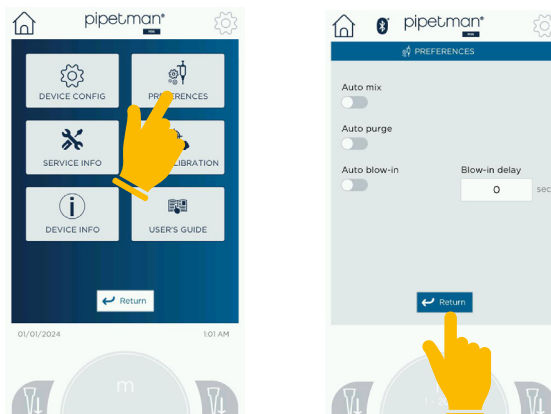

NOTE

Purge consists of emptying the tips after each pipetting step with a blow-out step to expel residual liquids from the tips. It is followed by a blow-in step, in which the piston returns to its initial position. During the blow-in step, a small amount of air is aspirated. **Ensure that the tips are not in contact with the liquid during blow-in to avoid any liquid aspiration.**





SERVICE INFO

- Define your next service date according to your SOPs. Choose either cycles, periods, or dates. When service is overdue, a pop-up will appear on the screen, and the Service icon will remain lit on the top of the screen.

If Admin control has been enabled in the General Parameters, you must enter the PIN code to access this menu.

- The Gilson Service button is accessible from Gilson Service representatives only by entering a unique PIN code, specific to Gilson. Complementary information can be filled in this menu when maintenance is done.



SELF-CALIBRATION

PIPETMAN M96 models are factory-calibrated using water for analytical laboratories (ISO 3696) and very high precision balances. If you prefer to work with mass rather than volume for solutions with a different density than analytical water, PIPETMAN M96 offers the option of self-adjustment at three points: 10%, 50%, and 100% of the nominal volume.

For that, volume vs. mass should be calculated using density. The calculated volume is set in a dedicated field of the SELF-CALIBRATION menu.

NOTE If Admin control has been enabled in the General Parameters, you must enter the PIN code to access this menu. The SELF-CALIBRATION function is not a regular service and maintenance.

CAUTION To revert to distilled water calibration, please disable the self-calibration option or enter the calibration information mentioned on the Gilson Test report provided with the device. If your laboratory procedures require the use of a certified ISO 8655 calibrated pipette, lock this mode with the Admin control function.

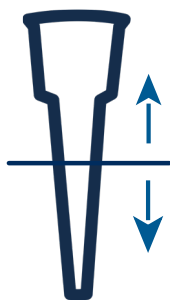

Set a lower measured volume to aspirate more (ex. set the volume at 190 μL)

Nominal volume (ex. 200 μL)

Set a higher measured volume to aspirate less (ex. set the volume at 210 μL)

DEVICE INFO AND USER GUIDE

- DEVICE INFO provides essential product identification and traceability elements, including manufacturer, model, serial number, and firmware version.
 - Touch the device name bar to rename your pipette.
 - A keyboard appears: enter the name and then select confirm.
- When pressing the User Guide button, a Data Matrix code will appear.

Scan it with a smartphone and you will reach our Gilson.com web page, containing complete product information such as the PDF version of the User Guide and Quick Guide, product specifications, flyer, and any information related to PIPETMAN M96.

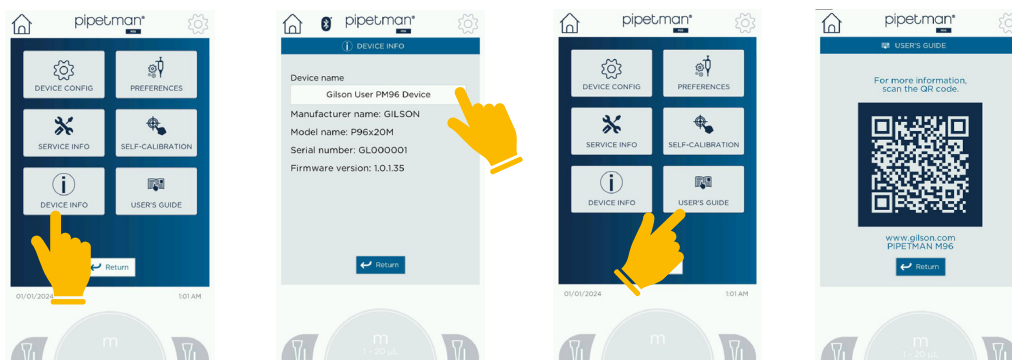



Fitting and Ejecting the Tips

It is recommended to use PIPETMAN® DIAMOND Tips for optimum performance. These tips are made from pure polypropylene. Plastic tips are for a single application—they must not be cleaned for reuse.

PIPETMAN® DIAMOND Tips offer a wide range of packaging. For increased productivity and minimal plastic waste, the use of Blister Refills and Reload Packs is recommended.

Associated PIPETMAN DIAMOND Tips

PIPETMAN® DIAMOND Tips			
Packaging Type	Standard Tips	Sterilized Tips	Sterilized Filter Tips
Blister Refill (Recommended)	D200 DS200 (384- certified) D300	D200ST DS200ST (384- certified) D300ST	DF30ST DSF30ST (384- certified) DF100ST DF200ST DSF200ST (384- certified) DF300ST
Reload Pack	D200	-	-
TIPACK™	D200 D300	D200ST D300ST	DF30ST DF100ST DF200ST DF300ST

For increased productivity and minimal plastic waste, the use of Blister Refills and Reload Packs is recommended

D200 tips are the reference tips for both P96x20M and P96x200M

NOTE

DF30ST tips are recommended to pipette up to 30 µL, and DF100ST up to 100 µL, for both P96x20M and P96x200

D300 tips are recommended to pipette volumes of liquids close to the nominal volume of the pipette, only for P96x200M

Adapters for Tips

Depending on the tips you choose, always use the right adapter to ensure a proper tip fitting and maximum performance.

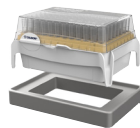
Blister Refill and Reload Pack (Recommended)		TIPACK	
Adapter for PIPETMAN DIAMOND Tips Blister Refills and Reload Packs (PIPETMAX Tip Reload Block)	Part Number	Adapter for PIPETMAN DIAMOND Tips TIPACK	Part Number
	32000175		FH07006
Place the tip rack on the adapter and then place the adapter on the microplate location.		Place the TIPACK on the adapter and then place the adapter on the microplate location.	

Tip Fitting

To fit 96 tips on the pin-plate:

- 1 Place the tips and their adapters under the pin-plate on the single tray or the multi-tray: tip holders of the pin-plate must be right above the tips. Use the positioning wheel of the multi-tray for a fine adjustment.
- 2 Lower the pipetting head so that the tip holders are inserted into the tips.
- 3 Lower the tip-fitting arm until the end to ensure a proper tip fitting. When you have reached the end of the lever, leave the tip-fitting arm: it will slowly return to its initial position by itself.
- 4 Lift the pipetting head with the fitted tips.
- 5 Remove the empty tip box or rack and place the labware or reservoir to start pipetting.



NOTE

To fit the tips, ensure that the height of the pipetting head is unlocked and that the height-fixing screw is at its lowest position.



PARTIAL TIP FITTING

PIPETMAN M96 can be fitted with less than 96 tips to improve your workflows and specific protocols that require partial tip fitting.

One or several rows of tips can be fitted. You can also define a special pattern to fit tips on the pin-plate and adapt the pipetting steps to a precise microplate filling map (for instance, to dispense specific liquids into specific wells) or adapt the use of the pipette to various microplates (for instance 12- or 48-well microplates).

Partial tip fitting using the multi-tray:

1. Place the tips and their adapter on the tray (either on the right or on the left of the tray).
2. Slide the tray under the pin-plate so that the desired number of tips to load corresponds to the tip holders. Tips must be right below the tip holders of the pin-plate. Refer to [Accessories Recommended for Optimal Usage](#) for further details on how to slide the multi-tray. Columns of tips can be fitted either on the left or the right of the pin-plate, according to the working protocol and the organization of the labware on the multi-tray.
3. When the tray is positioned under the pin-plate, fit the tips following the previous instructions using the tip-fitting arm.



Figure 7
PIPETMAN® M96 partial tip fitting using the multi-tray

Partial tip fitting using the single tray:

1. Prepare the tip rack by removing unnecessary tips and keeping only the desired ones.

Tips can be fitted on the left, right, or any desired tip holder.

Partial tip fitting using the single tray is a convenient way to fit tips when pipetting tasks with various microplates (such as 12-well microplates) are part of a protocol – without the need to slide the plate column by column.

2. When the rack is partially filled with tips, follow the previous [Tip-Fitting](#) instructions using the tip-fitting arm.

Left

Special pattern for 12-well microplates



NOTICE

Empty tip racks can also be filled with tips corresponding to the partial tip fitting desired pattern, following the Standard Operation Procedures (SOPs) of the laboratory to limit the risks of contamination.

Figure 8

PIPETMAN® M96 partial tip fitting using the single tray

Tip Ejection

Tips can be ejected anytime, during any pipetting step and from the Home screen.

Ejecting the tips when the pipette is not operating, before or at the end of a pipetting task

1. Touch the ejection button on the screen (for left or right-handed users), and a pop-up message will appear.
2. Place a container or a tip bin disposal to dispose of used tips and confirm the ejection by touching the Eject button.

NOTICE

Tips ejection is divided into two steps with a confirmation pop-up to avoid accidental tip ejection by unintentionally touching the ejection buttons on the screen.

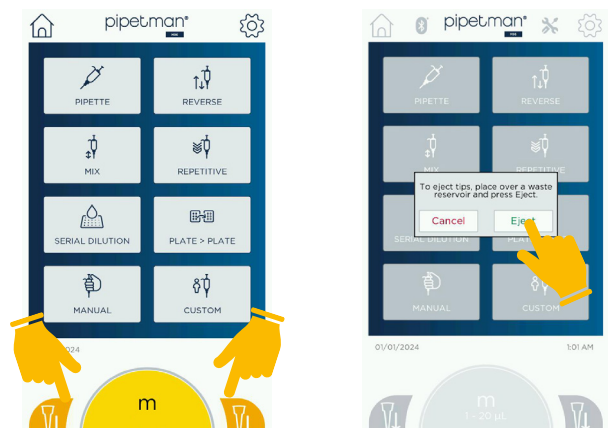

Ejecting the tips when the pipette is operating, or during a pipetting protocol:

During pipetting, the ejection buttons are inactive (grey color instead of yellow) until the purge and blow-in tasks have not been done.

- At the end of the tasks, ejection buttons are active: tips can be ejected as previously described.
- Before the end of a task, tips must be emptied of the remaining liquid before ejection. Touch the Abort button and follow the instructions on the screen to empty the tips and reach the pipetting function main page. Ejection buttons can then be activated to eject the tips as described in the previous paragraph.

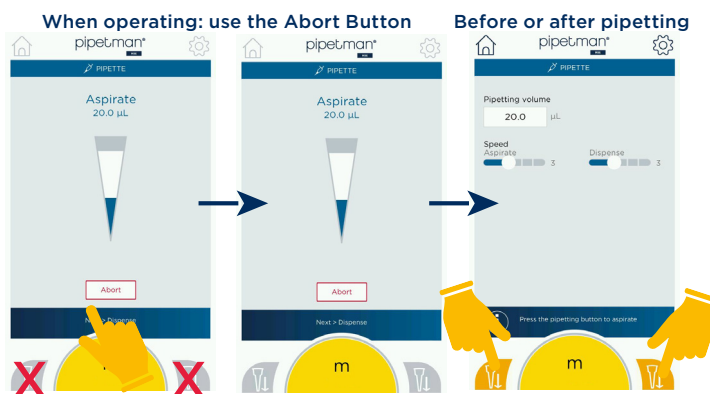

Abort will end the ongoing protocol and lead to the pipetting function main page.

NOTE

For custom protocols that combine several pipetting tasks with different liquids, tip ejection buttons are active after each task to allow ejection and new tip fitting before pipetting another liquid.

The use of the Abort button is recommended to eject tips full of liquid. It will end the running protocol, add purge and blow-in steps before allowing tip ejection.

Pipetting

PIPETMAN M96 is simple and intuitive, as easy to use as a pipette, and a **Contextual Help Bar** assists the user at each step of the protocol. For each mode, pressing on the **i** icon of the **Contextual Help Bar** will provide further assistance or explanations on the current pipetting mode.

Guidelines for Good Pipetting

- Change the tips before aspirating a different liquid, sample, or reagent. Each new tip should be pre-wetted with the liquid to be pipetted. Change the tip if a droplet remains at the end of the tip from the previous pipetting operation.
- When pipetting liquids with temperatures different from the ambient temperature, pre-wet the tip several times before use to reach equilibrium between the temperatures of the liquid and the pipette's dead volume. For volatile liquids, saturate the dead volume by repeatedly aspirating and dispensing the liquid before aspirating the sample.
- When aspirating, keep the tip at a constant depth below the surface of the liquid.

Model	Immersion Depth (mm)	Wait Time (Seconds)
P96x20M	2-3	1
P96x200M	2-4	1

NOTICE

The maximum immersion depth of the tips can be fixed using the height-fixing screw (refer to [Height Adjustment](#) for further details).

To remove droplets, re-immers the tips, then slightly move the microplate and put the tips against the wall of the wells.

The liquid should never enter the pin-plate. To prevent this, choose tips with a volume range adapted to the pipetting volume (refer to [Associated PIPETMAN DIAMOND Tips](#) for more details).

WARNING

Pipetting corrosive liquids may damage PIPETMAN M96 parts in contact with the solution. In case of contact, immediately clean up aggressive liquids.

Pre-Wet the Tips

Pre-wetting the tips before pipetting helps prepare the tips for the best pipetting performance. Ideally, the pre-wet includes both immersing the tip in the liquid and performing one or more pipetting steps (a minimum of five pipetting steps is recommended).

Pre-wetting the tips helps ensure that your pipette will achieve accurate and precise volumes within specifications.

PIPETMAN M96 enables the user to pre-wet the tips in different ways:

The **Mix mode is recommended**: set several mix cycles at mid or low speed to pre-wet the tips.

Pipette mode or Manual mode can also be used to pre-wet the tips, including a purge between each pipetting cycle (refer to [PIPETTING MODES AND APPLICATIONS](#) for further details).

Adjustable Finger Rests

To reinforce ergonomics, PIPETMAN M96 is equipped with adjustable finger rests that can move around an axis to fit any finger size and conveniently lift or lower the pipetting head.

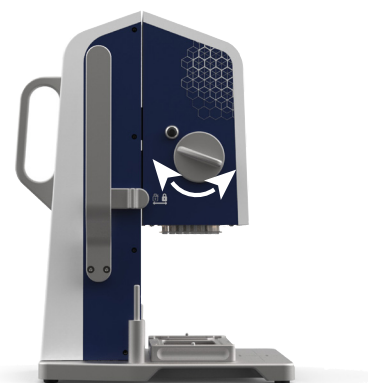

Figure 9
Adjustable finger rest





Height Adjustment

Adjust the pipette height to the microplate location or the labware being used.

Use the height-fixing screw to define the lowest possible pipetting height and prevent accidentally touching the bottom of the microplate wells:

- 1 Place the pipetting head at the desired lowest level
- 2 Unscrew and lift the height-fixing screw until it stops
- 3 Lock the screw
- 4 Mark your preferred height on the white sticker with dry-erase markers for reproducible results when pipetting in several microplates of the same kind.

NOTICE If the screw is at its lowest position, the pipetting head is free, and there is no minimal height defined. Height can be locked or adjusted at any time or during any pipetting task.

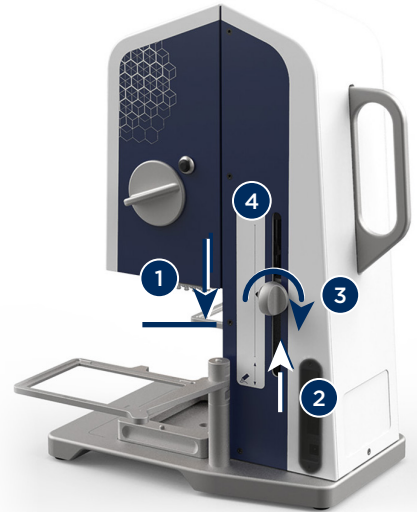

Pipetting

To start pipetting, place a vessel containing the liquid to be pipetted on the microplate area of the chosen accessories (refer to the [Accessories Recommended for Optimal Usage](#) for further details).

For each Pipetting mode:

- 1 From the Home screen, touch the button to reach the desired pipetting function.
- 2 Set the pipetting parameters (refer to detailed parameters in the [PIPETTING MODES AND APPLICATIONS](#)). A message will appear on the Contextual Help Bar to guide you to the next steps.

Press on the **i** icon of the Contextual Help Bar for further explanations on the current pipetting mode.

- 3 Push on the Pipetting button to start the task.

Either the central touchscreen button or the buttons on the side of the pipette can be used for a preferred way of pipetting and reinforced ergonomics.

- 4 Follow the instructions on the screen until the end of the task.



NOTE To stop a protocol before its end, touch the Abort button and follow the instructions on the screen to empty the tips and reach the pipetting mode main page.

Pipetting in 384-well Microplates

PIPETMAN M96 and its accessories enable pipetting in 384-well microplates with only four movements.

PIPETTING IN 384-WELL MICROPLATES WITH REVERSIBLE TRAYS

The single tray and rotating tray adapted to 384-well microplates enable the user to slide the microplate manually. Dimensions of the trays are larger than the size of the microplate to let the user move the microplate from one corner to another and fill a 384-well plate with 96 tips.

- 1 Place the microplate on the tray and ensure it is located at the first corner. Tips must be above the first series of wells. The plate is ready for the first pipetting step.
- 2 To reach the next series of wells, slide the microplate to the next position, on the second corner of the tray. Tips must be above the second series of wells. The plate is ready for the second pipetting step.
- 3 4 Repeat the operation for the two remaining series of wells: slide the plate to the next corner of the tray and pipette.

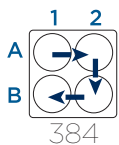

384-well microplate filling pattern: square from A1 to B1 well

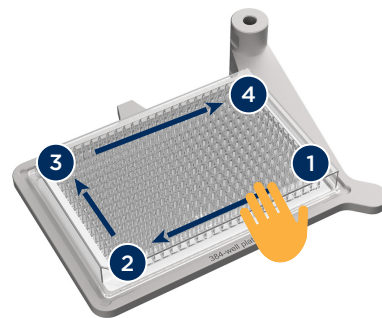
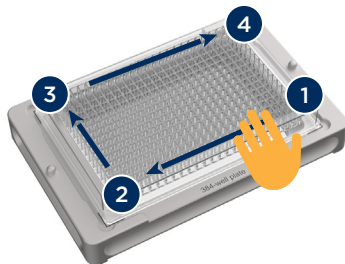



PIPETTING IN 384-WELL MICROPLATES WITH THE MULTI-TRAY

The multi-tray is equipped with two shifting levers: one to move back and forth the 384-well microplate, and one to set the preferred option to move the tray sideways – free sliding or with notches (refer to [Accessories Recommended for Optimal Usage](#), part multi-tray for more details).

Place the 384-well microplate under the pipetting head fitted with tips. Turn the positioning wheel to the 384-position.

Always ensure that the tips are right above the desired series of wells before pipetting.

1 Use the right shifting lever to place the first series of wells under the tips.

The neutral position is adapted to 96-well microplates: slide the lever to the right position  the plate is ready for the first pipetting step.

2 Move the tray sideways from the first column to the next one.

- **Position A** of the shifting lever: free slide of the tray without pre-set position
- **Position B**: pre-set positions of the column width – slide the tray from one column to another with a slight notch
- **Position C**: same as position B with a more significant notch

Tips are now placed above the next series of wells and the plate is ready for the second pipetting step.

3 Slide the back-and-forth lever to the left position .

Tips are above the third series of wells: the plate is ready for the third pipetting step.

4 Move the tray sideways to the previous column.

Tips are above the last series of wells: the plate is ready for the last pipetting step.

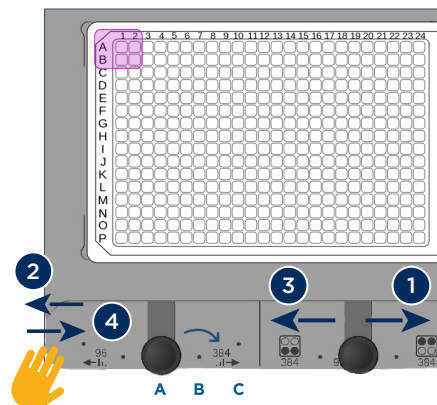
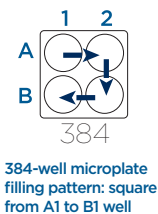

NOTE

The multi-tray is recommended for Plate-to-Plate transfer and Serial Dilutions (refer to [PIPETTING MODES AND APPLICATIONS](#) and [Accessories Recommended for Optimal Usage](#) for further details).

When pipetting from 384- to 384-well plates, ensure that the transfer follows the same plate pattern from one plate to the other.

PIPETTING FROM 96- TO 384-WELL MICROPLATES WITH THE MULTI-TRAY

Use both positioning wheels and shifting levers to transfer liquids from a 96- to a 384-well plate.

Select 96

When the plate is under the pipetting head



Select 384

When the plate is under the pipetting head

Use the shifting levers to move the tray sideways and back and forth.

Figure 10

Use of the multi-tray with 96- and 384-well microplates



Aborting

This option is available at each pipetting step and enables to stop a protocol anytime, empty the tips, and go back to the Pipetting function setting page.

Instructions are given on the screen to guide the user:



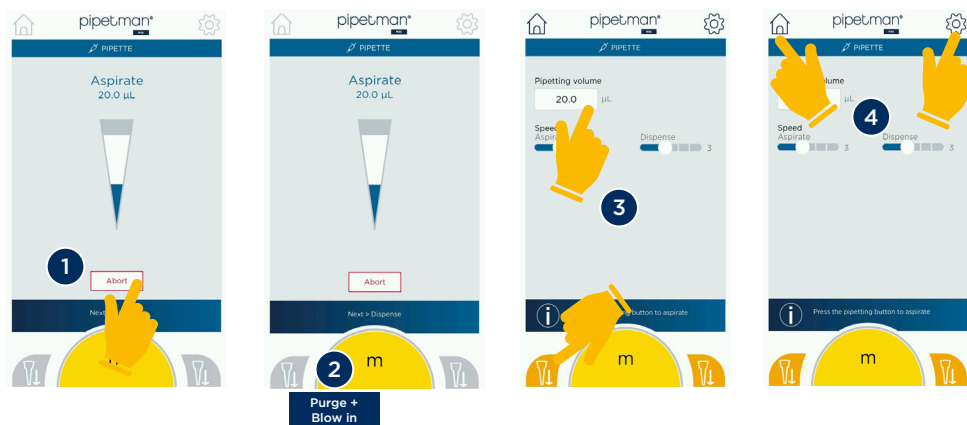





- 1 Press the Abort button
- 2 Follow the instructions and press on the pipetting button to eliminate the liquid remaining in the tips: purge and blow-in steps
- 3 The display is back to the pipetting function setting page: eject the tips and fit new ones if needed, and start the task again
- 4 Or touch the icons on the top of the display to reach the Home screen to change function or the parameters screen. Tips can also be ejected at this stage of the aborting process.



Chapter 5

PIPETTING MODES AND APPLICATIONS

Intuitive and easy-to-use, PIPETMAN M96 offers direct access to standard pipetting functions, and pipetting applications specific to the use of microplates: Plate-to-Plate and Serial Dilution modes.

Pipetting Modes Accessible from the Home Screen	Recommendations	Pipetting Modes Accessible from the Home Screen	Recommendations
 Pipette	All standard applications. Partial plate filling (with partial tip fitting).	 Reverse	Reverse pipetting mode is recommended for dense, foaming, or high vapor pressure liquids; cold or hot samples.
 Mix	Mix and homogenize different solutions right after a pipetting step. Perform several mix cycles at mid or low speed to pre-wet the tips (recommended)	 Repetitive	Dispensing aliquots. Filling several plates (ex. reagent addition, plate preparation).
 Serial Dilution	Diluting samples. Pipette + mix row by row with the select volume.	 Plate-to-Plate	Plate transfer, plate replication, and plate reformatting with one or up to 4 different liquids. Source plates: 96- or 384-well Destination plates: 96- or 384-well
 Manual	Manually controlled pipetting such as: multiple aspirations of supernatant, multiple dispenses of medium or reagent to fill plates without setting specific volume. Titration. ELISA: addition of the last reagent to stop a reaction.	 Custom	Creation of personalized protocols including different tasks. X-fold serial dilutions. Partial plate filling, plate filling with different liquids or samples.



NOTICE

When working with 6-, 12-, 24-, and 48-well microplates, follow the partial tip fitting instructions in [Fitting and Ejecting the Tips](#).

To remove droplets, re-immers the tips, then slightly move the microplate and put the tips against the wall of the wells.

The pipetting modes proposed, accessible from the Home screen, guide the user from the pipetting settings to the end of the tasks. They all follow the same workflow:

- 1 Define the pipetting settings
- 2 Execute using either the touchscreen or the buttons on the side of the pipette
- 3 Follow the instructions for the purge and blow-in steps
- 4 Back to the pipetting settings page to start again
- 5 Or touch the icons at the top of the display to reach the Home screen to change function or the parameters screen

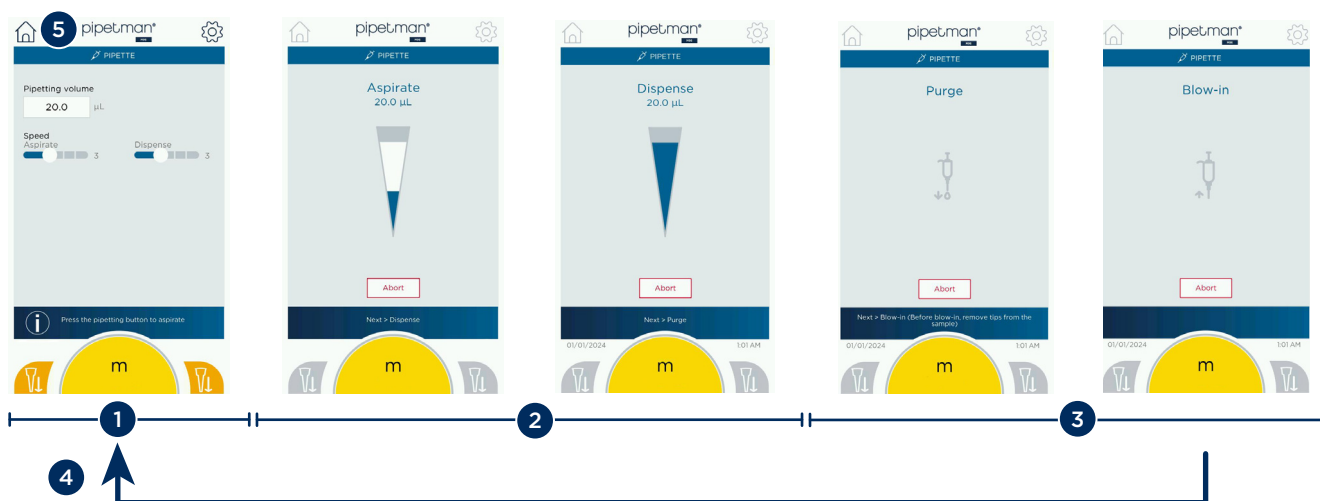

NOTE

Purge, blow-In, and mix preferences (auto or manual, delay) are set in the pipetting preferences and remain identical for all the pipetting modes.

Speeds are set at level 3/6 as factory settings, they can be modified anytime according to the liquids aspirated and dispensed. Modified settings are kept in memory by the pipette.

NOTICE

When working, the defined pipetting parameters (Volume, Mix Cycles, etc.) are indicated on the display, to guide and further assist during the pipetting tasks.

Tips can be replaced during the pipetting protocol, please refer to [Fitting and Ejecting the Tips](#) for more details.

To pre-wet the tips, use the Mix mode and then start the requested pipetting task by choosing the pipetting function on the Home screen.

Pipette

This is the classic pipette mode (forward pipetting) for simple aspirating and dispensing of a defined volume.

Set the volume and the pipetting speed before starting.

Pipette Mode Description		
	Pipetting Steps	Setting Parameters
	Aspirate Dispense Purge Blow-In	Pipetting volume Aspiration speed (1-6) Dispense speed (1-6)



Reverse

During Reverse mode, the aspirated volume is higher than the dispensed volume. After delivery, the excess volume remains in the tips and is discarded during the Purge step.

Set the volume and the pipetting speed before starting.

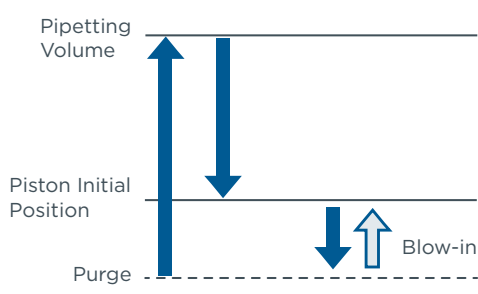
Reverse Mode Description		
	Pipetting Steps	Setting Parameters
	Aspirate Dispense Purge Blow-in	Pipetting volume Aspiration speed (1-6) Dispense speed (1-6)

Mix

This is the classic pipette mode (forward pipetting) followed by a mixing phase, composed of repeatedly aspirating and dispensing steps.

Set the pipetting and mix volumes, number of cycles, and pipetting speed before starting.

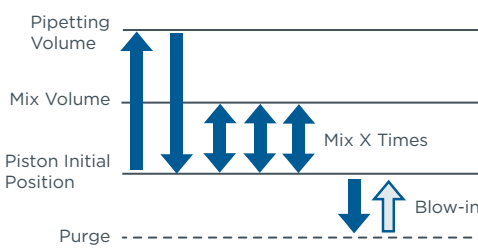
Mix Mode Description		
	Pipetting Steps	Setting Parameters
	Aspirate Dispense Mix (X times) Purge Blow-in	Pipetting volume Aspiration speed (1-6) Dispense speed (1-6) Mix volume Number of mix cycles Mix aspiration speed (1-6) Mix dispense speed (1-6)

NOTE

For better homogenization, the mixing volume can be higher than the pipetting volume.

Mix preferences (auto-mix or manual) are set in the [Pipetting Preferences \(Prefs\)](#). When auto mix is selected, mixing cycles will be done automatically after dispensing.

Low mixing speeds are recommended for a gentle mix of foaming liquids or samples containing proteins, enzymes, or cells that could be damaged with a strong mix.

Repetitive

The Repetitive mode allows distribution of the same volume repeatedly in a predefined number of equal aliquots. The pipette automatically calculates the number of aliquots possible from the nominal (maximum) volume of the pipette and according to the defined aliquot volume.

Define the aliquot volume and number, and the pipetting speed before starting.

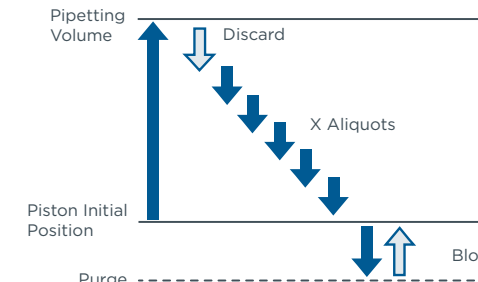
Repetitive Mode Description		
	Pipetting Steps	Setting Parameters
	Aspirate Discard Dispense aliquots (X Times) Purge Blow-in	Aliquot volume Number of aliquots Aspiration speed (1-6) Dispense speed (1-6) Mix volume Number of mix cycles Mix aspiration speed (1-6) Mix dispense speed (1-6)



NOTE

An extra volume is aspirated to ensure equal operating conditions for each dispensed aliquot. This discard step is mentioned on the touchscreen: discard this extra volume in a vessel different from the working microplate.

Used with partial tip fitting, the Repetitive mode can be used to multi-dispense aliquots in different columns of the microplate (ex. for serial dilutions).

NOTICE

If the requested number of aliquots X volume is higher than the nominal volume of the pipette, the pipette will adapt the aliquot numbers to the nominal volume of the pipette.
Ex: if 12 aliquots of 20 µL each are requested, they will be automatically adjusted in the pipetting settings display into 10 aliquots of 20 µL to reach the nominal volume of 200 µL.

Serial Dilution Using the Multi-Tray

The Serial Dilution mode allows 10-fold dilutions from one microplate column to another, or dilutions that require to transfer several times the same volume of liquid from one column to the other.

Define the dilution, mix parameters, and pipetting speed before starting.

Rows of eight tips can be fitted either on the left or right of the pipetting head (refer to [Fitting and Ejecting the Tips](#) for further details).

- Prepare the plates for serial dilution by adding the diluent or reagent, and the samples to dilute in the first column.
- Fit the row of tips and start the serial dilution mode following the instructions on the screen.
- Use the multi-tray to slide the microplate under the pipetting head from one column to another.
- **Position A** of the shifting lever: free slide of the tray without pre-set position
- **Position B**: pre-set positions of the column width – slide the tray from one column to another thanks to a slight notch
- **Position C**: same as position B with a more significant notch

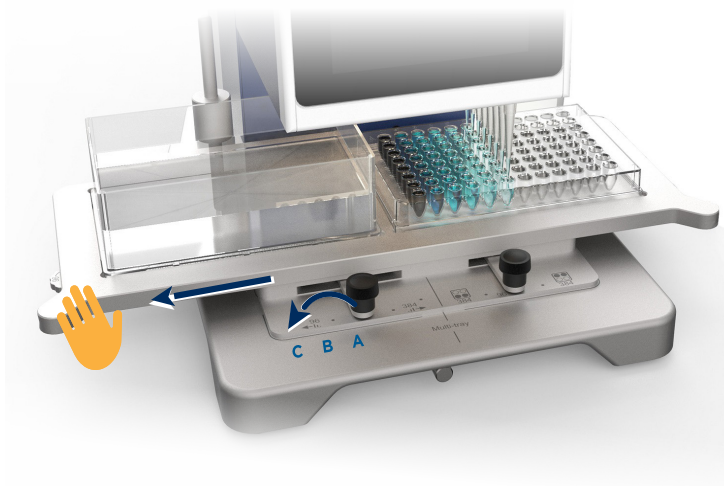

Serial Dilution Mode Description

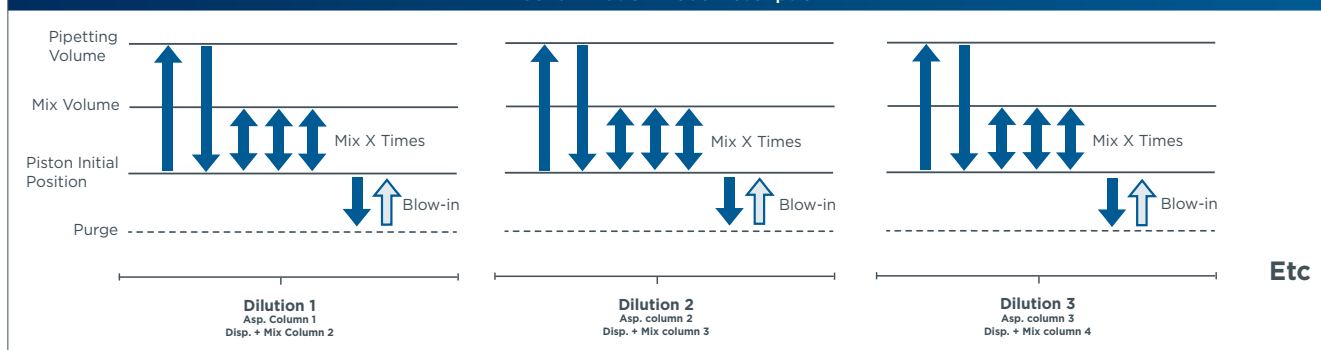

Pipetting Steps	Setting Parameters
<ul style="list-style-type: none"> • Aspirate (From Column 1) Dispense (To Column 2) Mix (In Column 2 X Times) Purge Blow-in • Aspirate (From Column 2) Dispense (To Column 3) Mix (In Column 3 X Times) Purge Blow-in • Etc. (Pipetting cycle repeated X times) 	Dilution volume (always the same) Number of dilutions Aspiration speed (1-6) Dispense speed (1-6) Mix volume Number of mix cycles Mix aspiration speed (1-6) Mix dispense speed (1-6)

NOTE

The number of dilutions corresponds to the number of columns in which the sample is dispensed.
Ex: 2 dilutions = aspiration from column 1 + dispense in column 2/mix/aspiration + dispense in column 3.

NOTICE

When the dilution factor is different from 10, or when the volume to dilute is different from one row to the other, use the Custom mode to program the different steps of the plate filling and dilutions.

Mix preferences (auto-mix or manual) are set in pipetting preferences.



Plate-To-Plate

The Plate-To-Plate mode allows to transfer liquids from one microplate to another.

- Press plate selection to define your microplate patterns.

Various combinations are possible from source to destination plates: transfer, replicate, or reformat microplates with one or up to four different liquids in only a few steps.

- Set the volume and the pipetting speeds.

For 384-well plates, the single tray, multi-tray, and reversible rotating trays 96-384 and 384-384 can be used. Please refer to [Pipetting in 384-well Microplates](#) and [Accessories Recommended for Optimal Usage](#) for further details.

NOTE Tips can be ejected and replaced between each pipetting task, please refer to [Tips Fitting and Ejecting](#) for further information.

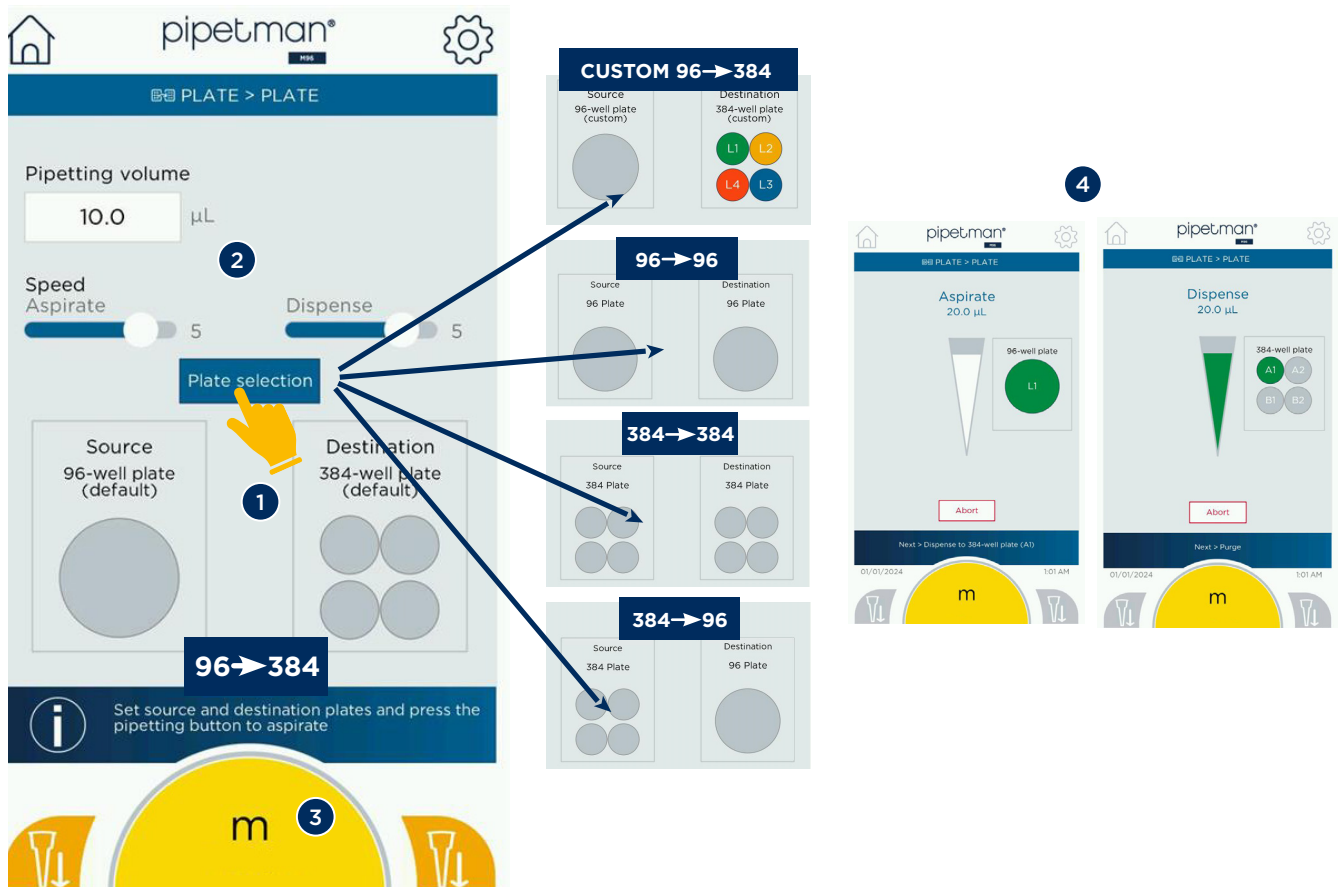

- 1 Touch the plate selection button and microplate patterns will appear on the screen. Various combinations are possible from source to destination plates
 - Source plates: 96- or 384-well
 - Destination plates: 96- or 384-well
 - The Custom 96 → 384 mode allows the user to fill 384-well microplates with up to four different liquids.
- 2 Set the pipetting volume and adjust the pipetting parameters
- 3 Touch the pipetting button to start the operation when ready
- 4 Follow the instructions on the screen until the end of the tasks (purge, blow-in)

NOTICE The 96- to 384-well microplates with only one liquid is the default mode. The Plate-to-Plate settings page will always display this mode. Press plate selection several times to reach the desired plate pattern.

During pipetting in 384-well microplates, the screen will indicate in which well liquid must be dispensed. The microplate filling follows the pattern described in [Pipetting in 384-well Microplates](#).

When pipetting in 384-well plates with different liquids using the default 96=>384 mode or the 384=>384 mode, the pipette will not provide any assistance regarding the nature of the liquids that need to be pipetted. Users will have to monitor which liquid goes into which well.



Plate-to-Plate Mode Description

From 96- to 384-well Microplates (Standard Mode, and Custom Plate-To-Plate Mode Examples)

	Pipetting Steps	Setting Parameters
<p style="text-align: center;">STEP 1 STEP 2 STEP 3 STEP 4</p>	<p>When the same liquid or no indication on liquids: Pipette mode</p> <ul style="list-style-type: none"> Aspirate from plate 96 Dispense in well 1/4 in plate 384 Purge Blow-in Aspirate from plate 96 Dispense in well 2/4 in plate 384 Purge Blow-in Same operations in wells 3/4 Same operations in wells 4/4 	<p>Pipetting volume Aspiration speed (1-6) Dispense speed (1-6)</p>
<p style="text-align: center;">STEP 1 STEP 2 STEP 3 STEP 4</p>	<p>When four different liquids: Pipette mode</p> <ul style="list-style-type: none"> Aspirate liquid 1 (green) from plate 96 Dispense (green) in well 1/4 in plate 384 Purge Blow-in - change tips if needed Aspirate liquid 2 (yellow) from plate 96 Dispense (yellow) in well 2/4 in plate 384 Purge Blow-in - change tips if needed Same operations with liquid 3 (blue) in wells 3/4 Same operations with liquid 4 (orange) in wells 4/4 	<p>Pipetting volume Aspiration speed (1-6) Dispense speed (1-6)</p>
<p style="text-align: center;">STEP 1 Repetitive Mode 2 Aliquots</p> <p style="text-align: center;">STEP 2 STEP 3</p>	<p>When two wells one after the other are filled with the same liquid: Repetitive* and Pipette mode</p> <ul style="list-style-type: none"> Aspirate liquid 1 (green) from plate 96 Discard Dispense aliquot 1 (green) in well 1/4 in plate 384 Dispense aliquot 2 (green) in well 2/4 in plate 384 Purge Blow-in - change tips if needed Aspirate liquid 2 (yellow) from plate 96 Dispense (yellow) in well 3/4 in plate 384 Purge Blow-in - change tips if needed Same operations with liquid 3 (blue) in wells 4/4 	<p>Pipetting volume (when aliquots: they are automatically calculated to correspond to the pipetting volume) Aspiration speed (1-6) Dispense speed (1-6)</p>

*If the total volume to pipette with the same liquid does not exceed the nominal volume (otherwise: Pipette mode).

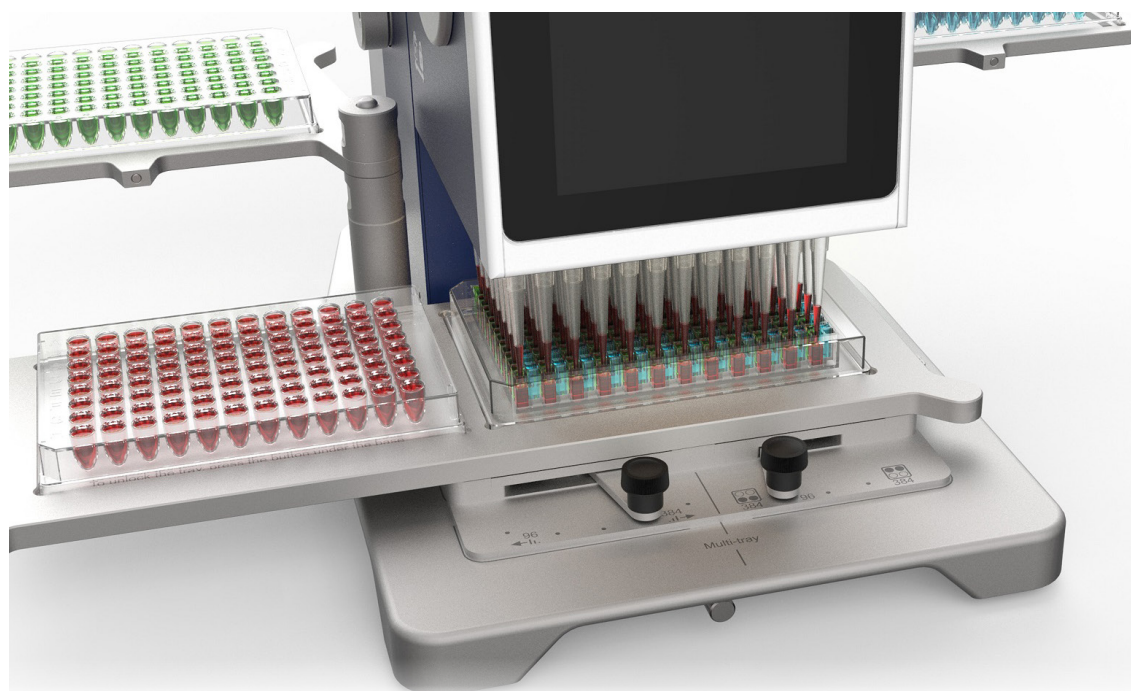



Plate-to-Plate Mode Description From 96- to 96-well Microplates		
	Pipetting Steps	Setting Parameters
	<ul style="list-style-type: none"> Aspirate from plate 96 Dispense in plate 96 Purge Blow-in 	<ul style="list-style-type: none"> Pipetting volume Aspiration speed (1-6) Dispense speed (1-6)

Plate-to-Plate Mode Description From 384- to 384-well Microplates		
	Pipetting Steps	Setting Parameters
	<ul style="list-style-type: none"> Aspirate from well 1/4 in plate 384 Dispense in well 1/4 in plate 384 Purge Blow-in Aspirate from well 2/4 in plate 384 Dispense in well 2/4 in plate 384 Purge Blow-in Same operations in wells 3/4 Same operations in wells 4/4 	<ul style="list-style-type: none"> Pipetting volume Aspiration speed (1-6) Dispense speed (1-6)

Plate-to-Plate Mode Description From 384- to 96-well Microplates (same liquid in each well of the 384-well Microplate)		
	Pipetting Steps	Setting Parameters
	<ul style="list-style-type: none"> Aspirate from well 1/4 in plate 384 Dispense in plate 96 Purge Blow-in Aspirate from well 2/4 in plate 384 Dispense in plate 96 Purge Blow-in Same operations from wells 3/4 Same operations from wells 4/4 	<ul style="list-style-type: none"> Pipetting volume Aspiration speed (1-6) Dispense speed (1-6)

Manual Pipetting

The Manual Pipetting mode allows for aspiration and dispensing as long as the pipetting button is held. Unique or multiple aspirations can thus be done according to the working protocol.

This mode can be used when there is no need for a precise volume of liquid to handle.

Set the maximum aspirated volume and the pipetting speed before starting. During execution, touch move to dispense to switch from aspirate to dispense.

Manual Pipetting Mode Description		
	Pipetting Steps	Setting Parameters
	<ul style="list-style-type: none"> Aspirate (manually activated) Move to dispense (button) Dispense (manually activated) Purge Blow-in 	<ul style="list-style-type: none"> Maximum aspirated volume Aspiration speed (1-6) Dispense speed (1-6)

NOTE The maximum aspirated volume corresponds to the total volume when one or several aspirations are done. It can be set up to the nominal volume of the pipette or below.

NOTICE When pipetting the screen indicates the approximate volume of liquid in the tips. It corresponds to the total aspirated volume when aspirating, and the remaining volume of liquid in the tips during dispensing. This indication is provided for information purposes only and is not for accurate and precise volume measurement.

Switching from aspiration to dispense can be done before the maximum aspirated volume has been reached. When the dispensing has started, the pipette will not return to aspiration.



Custom

The Custom mode allows the creation of personalized pipetting protocols, including different tasks or using existing protocols (previously created).

- Select a protocol to view or to start.
- Touch the pencil button to edit a protocol, create a new one, or reorganize the list of protocols.
- Up to 40 protocols, each including up to 99 tasks, can be created and edited from the Custom page.

NOTE

Custom protocols can also be created from a laptop using PIPETMAN M Software (refer to [PIPETMAN® M Software](#) for further details).

NOTICE

To avoid any accidental change of the protocol or to follow your SOPs, protocols can be locked if the Admin control function has been enabled. Touch the General Parameters icon  and reach the DEVICE CONFIGURATION page to activate the Admin control toggle.

Protocols can be modified when the protocol edit option is unlocked: touch the padlock icon and enter the PIN code set in the DEVICE CONFIGURATION / enable Admin control menu. The protocol will be temporarily unlocked and will be automatically locked again after the modifications.

PIPETMAN M96 records all the modifications in real-time, and new protocols or modified tasks are automatically saved.

Run a Preset Protocol

To run a preset protocol, from the Custom mode main screen:

- 1 Select the protocol to run.
- 2 To view the tasks or to edit the selected protocol before starting, touch the protocol edit button. This step can be skipped if you want to start the protocol right from the list.
- 2A The View protocol icon enables the user to consult the list of tasks of a locked protocol.
- 2B The Edit protocol icon is available when protocols are not locked, and the protocol can be modified before starting.
- 3 Touch the pipetting button to start the selected protocol.
- 4 The starting page of the protocol is displayed: touch the pipetting button to start and follow the pipetting instructions until the end of the protocol - refer to [PIPETTING MODES AND APPLICATIONS](#) for further details on each pipetting function that could be part of the protocol.

Edit, Modify, and Create Protocols

Editing and modifying protocols can be done when protocols are unlocked or when the padlock icon is touched: a pop-up will appear. Enter the Admin PIN code and the protocol is temporarily unlocked for modifications.





TO EDIT THE LIST OF PROTOCOLS AND TO CREATE A NEW PROTOCOL

- From the main page of the Custom mode, touch the button edit list of protocols.

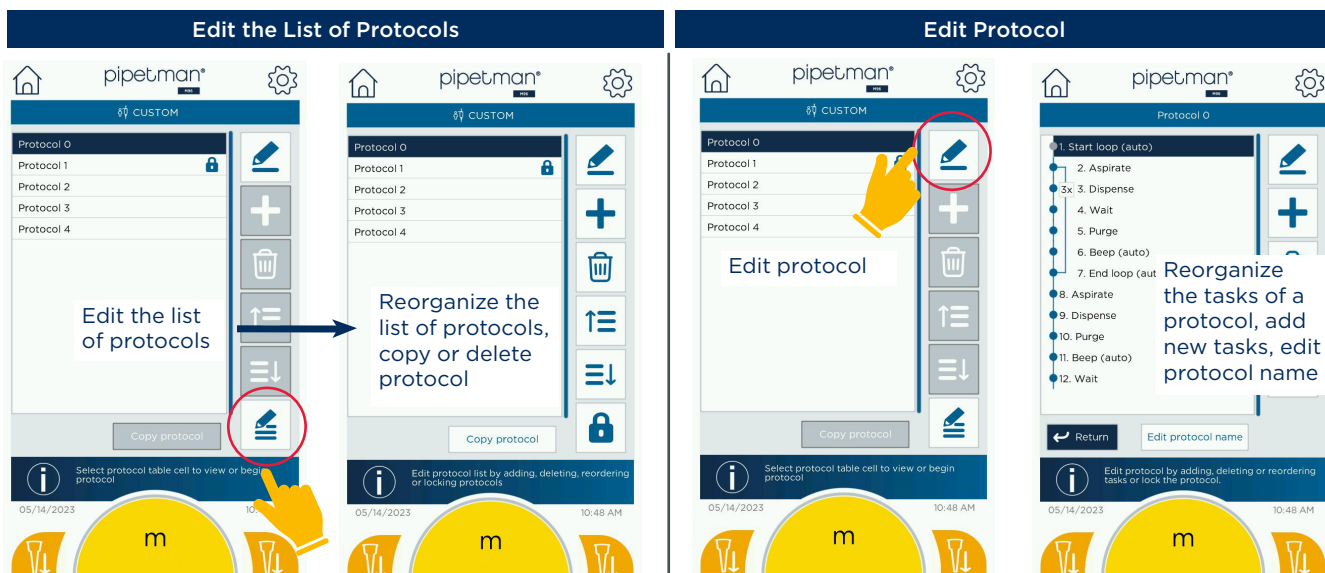

If Admin mode is enabled or if protocol is locked: touch the padlock icon and enter the PIN code

Use the buttons on the right of the screen to reorganize the list, copy a protocol, create a new one, or delete a protocol. To create a protocol, press the + icon and follow the steps (modify the tasks of an edited protocol).

TO MODIFY THE TASKS OF AN EDITED PROTOCOL

Select the protocol from the Custom mode's main page and touch the edit protocol button. To change the name, touch the edit protocol name. A keyboard will appear:

- Tap the protocol name
- Then touch Confirm.

To add new steps:

- Touch the + icon and select the task
- Set the task parameters
- Then touch Confirm.

To modify pipetting parameters on existing steps: touch the concerned step and the edit icon.

Erroring steps are highlighted in red (for instance when the aspiration volume is higher than the nominal volume of the pipette). They need to be modified, adapted, or removed accordingly.

To remove a task from the protocol:

- Select it and touch the Delete icon.
- A pop-up will appear: touch Confirm to delete the task.

To move up or down a protocol step:

- Select the task
- Press the up or down icons.

Use the padlock icon to lock the protocol. It can be temporarily unlocked with the Admin PIN code.

When the protocol is finalized:

- Touch the pipetting button to start or press Return to go back to the Custom Home screen.

Task Setting Parameters

Task	Parameters	Task	Parameters
Aspirate	Aspirate volume Aspiration speed (1-6) Button activates on click	Mix	Mix volume Number of mix cycles Mix aspiration speed (1-6) Mix dispense speed (1-6) Button activates on click
Dispense	Dispense volume Dispense speed (1-6) Button activates on click	Wait	Duration Button activates on click
Dispense all	Dispense speed (1-6) Button activates on click	Purge (+ auto blow-in)	Button activates on click
Reverse	Pipette volume Aspiration speed (1-6) Dispense speed (1-6) Button activates on click	Beep	-
Repetitive	Aliquot volume Number of aliquots Aspiration speed (1-6) Dispense speed (1-6)	Loop	Loop count

The **activate on click** toggle enables the execution of a task automatically or when the pipetting button is pressed. When “Activate on click” is selected, the task will start only when the pipetting button is pressed. When tasks are done automatically, “(Auto)” will appear after the name of the task on the screen as a reminder.

In the Custom protocol, **blow-in is automatically done after the purge**. Purge and blow-in are linked together in the purge task to ensure that the piston of the pipette always returns to its initial position after a purge step. If a blow-in delay has been set in the Pipetting preferences, it will be kept between purge and blow-in also in the Custom mode.

NOTE

When Mix is placed after Aspiration, the maximum mix volume is the aspirated volume. To adapt the mix volume at a higher volume than the aspirated volume, add a Dispense task: Aspiration – Dispense – Mix. In that case, the highest mix volume possible is the nominal volume of the pipette.

When the **Loop** has been selected and the count loop is defined at 0, an error message will appear on the screen mentioning that the Loop count is invalid. To remove the Loop, follow the instructions in [Modify the Tasks of an Edited Protocol](#).

To set a timer (ex. Incubation 30 minutes), select the task Wait, add 30 minutes in the duration parameter and rename it Incubation 30'. This task can be preceded and followed by the Beep task to remind you that the incubation time is done.

To integrate a **pre-wet step** in a custom protocol, add one or several pipetting and mixing cycles between two steps of the protocol.

Chapter 6 CLEANING

PIPETMAN M96 and its accessories are designed so that the parts in contact with contaminants can regularly and easily be cleaned and decontaminated.

Wipe PIPETMAN M96 and the trays with a soft cloth dampened with a mild detergent and disinfect as needed.

NOTICE

Standard laboratory cleaning and disinfecting solutions can be wiped on the pipette, such as: sodium hypochlorite (chlorine bleach), hydrogen peroxide, ethanol, and surface decontaminants (eg. RNaseZap, Lookout® DNA Erase). Avoid using highly concentrated solutions or solvents that could damage the cover, the colored housing of the pipette, or the identification label on the back of the pipette (e.g. isopropanol, methanol, or solvents like dichloromethane and chloroform).

CAUTION

Turn the power off and unplug the power cable before cleaning.

The liquid must not enter inside the pipette.

If the surfaces of PIPETMAN M96 or the trays have been in contact with biohazardous material, they must be decontaminated according to the laboratory Standard Operating Procedures (SOP).



TROUBLESHOOTING

In case of malfunction, first, switch off the pipette by pressing the 0 position on the switch button and switch it on again.

If the problem persists, you may consult the following table that identifies potential problems and their solutions.

Problem	Possible Cause	Action
Tips cannot be loaded	The pipetting head is locked and cannot reach the lowest position to fit the tips	Ensure that the height of the pipetting head is unlocked and that the height-fixing screw is at its lowest position
	Pin-plate and tip holders are not aligned with the tips	Replace the tips and adapters on the tray. When using the multi-tray: slide the tray and align it to ensure that the tips are under the corresponding tip holders
	Tips are fitted without their box adapter	Use the right adapter to fit tips. Refer to Fitting and Ejecting the Tips
	The tips used are not the recommended ones	Use only the recommended PIPETMAN DIAMOND Tips
Tips fall or do not fit	Tips have not been fitted correctly	Lower the pipetting head so that the pin-plate is in contact with the collars of the tips. Lower the tip-fitting arm until the end to ensure a proper tip fitting. Refer to Fitting and Ejecting the Tips
	The tips used are not the recommended ones	Use only the recommended PIPETMAN DIAMOND Tips
Tips are not aligned with the wells of the microplate	The microplate is not an SLAS-standard one	Use only SLAS-standard microplates. For 6-, 12-, and 48-well plates, define the partial tip fitting pattern so that fitted tips are aligned with the center of each well
	The tray is not correctly installed	Remove it and replace it according to the recommendations provided in Accessories Recommended for Optimal Usage
	The multi-tray is not in the right place	Use the positioning wheels and shifting levers (sideways and back and forth) to align the microplate with the tips
The pipetting head cannot be lowered to start pipetting	The pipetting head is locked and cannot reach the lowest position	Ensure that the height of the pipetting head is unlocked and that the height-fixing screw is at its lowest position
The pipette is leaking the sample	Operating parameters are extreme	Work according to the parameters. Refer to Specifications
	High vapor pressure liquids	Pre-wet the tips and use the Reverse mode. Pipetting speed can be adapted to different liquids
	Tips are not fitted correctly	Empty and eject the tips, and follow the tip fitting instructions to ensure a proper tip fitting
The touchscreen is not responding	Wet screen	Gently wipe and dry the screen, switch off the pipette, and switch it on again.
The touchscreen is black	Power issue	Make sure that PIPETMAN M96 is connected to the external power supply, and that the external power supply is connected to a power source.
Multi-tray is not sliding	Wrong installation	Unlock the multi-tray by pushing the button under the base, remove and reinstall it
Multi-tray cannot be removed	The button has not been unlocked before removing the tray	Unlock the multi-tray by pushing the button under the base and removing it

NOTE

If you cannot solve the problem, contact your local Gilson-authorized service center.



MAINTENANCE AND SPARE PARTS

PIPETMAN M96 requires very little maintenance. However, to ensure pipette accuracy, precision, and performance, please contact your local Gilson service provider, and proceed periodically with a leak test to check the pipette.

CAUTION

Maintenance of any part must be carried out only by trained Gilson personnel. Changes or modifications to the instrument not expressly approved by Gilson could void the factory-authorized warranty.

Leak Test

1. Fit the PIPETMAN DIAMOND Tips
2. Set the pipette to its nominal volume
3. Pre-wet the tips with the Mix mode
4. Aspirate the set volume from a reagent reservoir of distilled water
5. Maintain the pipette in the vertical position and wait for 20 seconds:
 - If a water droplet appears at the end of the tip, there is a leak
 - If you see no droplets, for P96x20M models, re-immers the tip below the surface of water.
 - The water level inside the tip should remain constant, if the level goes down there is a leak

NOTE

If there is a leak, refer to [TROUBLESHOOTING](#).

Use of Lubrication Box

In case of intensive use between each maintenance interval, and to avoid bad tip fitting, it is recommended to lightly lubricate the external O-rings of the pin-plate using the lubrication box part number F1077606.

Proceed as follows:

1. Open the box lid
2. Follow the [Tip Fitting](#) instructions
3. Eject the tips

The O-rings lubrication is complete.

Using a no-fiber wipe, remove any excess lubricant on the pin-plate.

Spare Parts

Accessories	
Model	Part Number
Power Supply	FH07008
Power cord EU	FH07009
Power cord UK	FH07010
Power cord US - JPN	FH07011
Power cord AUS	FH07012
USB-C Cable	FH07013
Lubricant	
Lubrication Box Of O-Rings	F1077606



SOFTWARE AND CONNECTION

PIPETMAN® M96 Software

With PIPETMAN M96 Software, you can create, save, and transfer protocols directly on a computer, providing an alternative to designing protocols through PIPETMAN M96's built-in Custom Mode. Additionally, it offers access to firmware updates that help maintain optimal performance.

Download the software at <https://www.gilson.com/default/pipetman-m96.html>

Please refer to the PIPETMAN M96 Software User Guide LT801691 available on gilson.com for further information and software compatibility.

NOTE

PIPETMAN M96 Bluetooth-connected models are available in select locations. Please contact your Gilson representative for more details.

Bluetooth can be enabled or disabled from the [Device Config](#) page. When enabled, the Bluetooth logo will appear on the top bar of the screen, near the Parameters logo.

REGULATORY COMPLIANCE

Gilson certifies on its sole responsibility that PIPETMAN M96 and PIPETMAN M96 Bluetooth-connected models comply with the requirements of the following standards:

EU Regulation All Models

2014/30/EU Electromagnetic compatibility, EMC

2014/35/EU Low Voltage Directive, LVD

2011/65/EU Restriction of Hazardous Substances (RoHS-2)

(EU) 2015/863 Restriction of Hazardous Substances (RoHS-3)



EU Regulation for Bluetooth-Connected Products

2014/53/EU Radio Equipment Directive

UK Regulation All Models

Electromagnetic Compatibility, Regulation 2016

Electrical Equipment (Safety), Regulation 2016

Radio Equipment Regulation 2017/1206



WEEE

The WEEE symbol (crossed-out wheeled bin), according to the European Directive 2012/19/EU, indicates separate collection for WEEE – Waste of Electrical and Electronic Equipment.

Do not dispose of electronic devices and their batteries in a household bin, use the recycling path in place in your country.



USA User Information

This device complies with Part 15 of the FCC Rules. Operation is subject to the following two conditions:

(1) This device may not cause harmful interference,

(2) This device must accept any interference received, including interference that may cause undesired operation.



CAUTION

Any changes or modifications not expressly approved by the party responsible for compliance could void the user's authority to operate the equipment.

Regulatory Compliance for Bluetooth-Connected Models

This Bluetooth-enabled device also complies with the following requirements:

USA, User information: Contains FCC ID: 2AAQS-ISP1807

CAUTION

Any changes or modifications not expressly approved by Gilson and the party responsible for compliance could void the user's authority to operate the equipment.

Canada, User information: Contains IC: 11306A-ISP1807

This device complies with Industry Canada license-exempt RSS standard(s). Operation is subject to the following two conditions: (1) this device may not cause interference, and (2) this device must accept any interference, including interference that may cause undesired operation of the device.

Le présent appareil est conforme aux CNR d'Industrie Canada applicables aux appareils radio exempts de licence. L'exploitation est autorisée aux deux conditions suivantes : (1) l'appareil ne doit pas produire de brouillage, et (2) l'utilisateur de l'appareil doit accepter tout brouillage radioélectrique subi, même si le brouillage est susceptible d'en compromettre le fonctionnement.

Japan certification n° O20 -200037  020-200037

South Korea, KCC Certification n° R-C-iNs-ISP1807

WARRANTY

Gilson warrants this device against defects in material under normal use and service for a period of **24 months** from the date of purchase.

This warranty shall not apply to devices which are subject to abnormal use and/or improper or inadequate maintenance (contrary to the recommendations given in the user guide), including, but not limited to devices which have been subjected to physical damage, improper handling, spillage or exposure to any corrosive environment. This warranty shall also be void in the event devices are altered or modified by any party other than Gilson or its designates. Gilson's sole liability under this warranty shall be limited to, at Gilson's sole option, repair or replacement of any defective components of devices or refund of the purchase price paid for such devices.

THE FOREGOING WARRANTY IS EXCLUSIVE AND GILSON HEREBY DISCLAIMS ALL OTHER WARRANTIES, WHETHER EXPRESS OR IMPLIED, INCLUDING ANY WARRANTIES OF MERCHANTABILITY AND ANY WARRANTIES OF FITNESS FOR A PARTICULAR PURPOSE, UNDER NO CIRCUMSTANCES SHALL GILSON BE LIABLE FOR ANY CONSEQUENTIAL, PUNITIVE, INDIRECT OR INCIDENTAL DAMAGES ARISING OUT OF ANY BREACH OF ANY EXPRESS OR IMPLIED WARRANTY.



Appendix A - Example of a Performance Check

Below is an example of how to evaluate the performance of PIPETMAN P10M at 2 µL.

1. Determine the mean value \bar{e} of the evaporation loss e_i that occurs during your pipetting cycles. Proceed as described in Appendix C - Evaporation Loss on page 53 to determine \bar{e} .

$$\bar{e} = \frac{1}{m} \sum_{i=1}^m e_i$$

m : number of weighings

$$e_1 = 0.016 \text{ mg} \quad e_3 = 0.021 \text{ mg}$$

$$e_2 = 0.018 \text{ mg} \quad e_4 = 0.017 \text{ mg}$$

$$\bar{e} = (e_1 + e_2 + e_3 + e_4) / 4$$

$$\bar{e} = (0.016 + 0.018 + 0.021 + 0.017) / 4$$

$$\bar{e} = 0.018 \text{ mg/per cycle}$$

2. Change the pipette tip and perform the first weighing. Then, keep a regular cycle and perform the ten following measurements.

$$W_r = 1,994 \text{ mg}$$

$$W_1 = 1,995 \text{ mg} \quad W_6 = 2,001 \text{ mg}$$

$$W_2 = 1,998 \text{ mg} \quad W_7 = 1,996 \text{ mg}$$

$$W_3 = 2,002 \text{ mg} \quad W_8 = 1,994 \text{ mg}$$

$$W_4 = 1,996 \text{ mg} \quad W_9 = 1,997 \text{ mg}$$

$$W_5 = 1,998 \text{ mg} \quad W_{10} = 1,997 \text{ mg}$$

W_r rinsing measurement which is disregarded for the calculation

3. Calculate the mean weight

$$\bar{W} = \frac{1}{n} \sum_{i=1}^n W_i$$

n number of weighings

W_i weighing results

$$\begin{aligned} \bar{W} &= (1,994 + 1,995 + 1,998 + 2,002 \\ &\quad + 1,996 + 1,998 + 2,001 + 1,996 \\ &\quad + 1,994 + 1,997 + 1,997) / 10 \end{aligned}$$

$$\bar{W} = 1,997 \text{ mg}$$

4. Calculate the mean volume. For a temperature of 21.5°C and an air pressure of 1013 hPa, the Z factor is equal to 1.0032 µL/mg (see table 3 in Appendix B - Z Factor on page 52).

$$\bar{V} = (\bar{W} + \bar{e}) \times Z$$

$$\bar{V} = 1.997 + 0.018 \times 1.0032$$

$$\bar{V} = 2.021 \text{ µL}$$

5. Evaluate accuracy

Systematic error (E): $E = \bar{V} - V_0$
 V_0 true value set on the instrument
 $E = 2.021 - 2 = 0.021 \text{ µL}$

Relative error (E%): $E\% = (\bar{V} - V_0) \times 100 / V_0$
 $E\% = 0.021 \times 100 / 2 = 1.05\%$

6. Evaluate precision (repeatability)

Standard Deviation (SD_w)

$$SD_w = \sqrt{\sum_{i=1}^n \frac{(W_i - \bar{W})^2}{n - 1}}$$

$$SD_w^2 = \frac{1}{n - 1} \sum_{i=1}^n (W_i - \bar{W})^2$$

$$SD_w^2 = \frac{1}{10} \left[\begin{aligned} &(1,994 - 1,997)^2 + (1,995 - 1,997)^2 + (1,998 - 1,997)^2 + \\ &(2,002 - 1,997)^2 + (1,996 - 1,997)^2 + (1,998 - 1,997)^2 + \\ &(2,001 - 1,997)^2 + (1,996 - 1,997)^2 + (1,994 - 1,997)^2 + \\ &(1,997 - 1,997)^2 + (1,997 - 1,997)^2 \end{aligned} \right]$$

$$SD_w = 0,002 \text{ mg}$$

Random error (SD_v):

$$SD_v = SD_w \times Z$$

$$SD_v = 0.002 \times 1.0032 = 0.002 \text{ µL}$$

Appendix B - Z Factor

The reference calculation equation is :

$$Z = [1/(P_w - P_A)] [1 - (P_A/P_B)]$$

Where:

- P_A = density of air at $t^{\circ}\text{C}$.
- P_w = density of the test liquid at $t^{\circ}\text{C}$.
- P_B = density of the balance weights.
- Use 8 g/cc for P_B

NOTE

Weights conforming to International recommendation N°33 of OIML have been adjusted to give results when weighing in air as if the density of the weights were 8.0 g/mL.

Values of the conversion factor Z ($\mu\text{L}/\text{mg}$) as a function of temperature and pressure for distilled water.

Table 2

Z Factor

TEMPERATURE AIR PRESSURE (HPA)						
(°C)	800	853	907	960	1013	1067
15	1.0018	1.0018	1.0019	1.0019	1.0020	1.0020
15.5	1.0018	1.0019	1.0019	1.0020	1.0020	1.0021
16	1.0019	1.0020	1.0020	1.0021	1.0021	1.0022
16.5	1.0020	1.0020	1.0021	1.0022	1.0022	1.0023
17	1.0021	1.0021	1.0022	1.0022	1.0023	1.0023
17.5	1.0022	1.0022	1.0023	1.0023	1.0024	1.0024
18	1.0022	1.0023	1.0024	1.0024	1.0025	1.0025
18.5	1.0023	1.0024	1.0025	1.0025	1.0026	1.0026
19	1.0024	1.0025	1.0025	1.0026	1.0027	1.0027
19.5	1.0025	1.0026	1.0026	1.0027	1.0028	1.0028
20	1.0026	1.0027	1.0027	1.0028	1.0029	1.0029
20.5	1.0027	1.0028	1.0028	1.0029	1.0030	1.0030
21	1.0028	1.0029	1.0030	1.0030	1.0031	1.0031
21.5	1.0030	1.0030	1.0031	1.0031	1.0032	1.0032
22	1.0031	1.0031	1.0032	1.0032	1.0033	1.0033
22.5	1.0032	1.0032	1.0033	1.0033	1.0034	1.0035
23	1.0033	1.0033	1.0034	1.0035	1.0035	1.0036
23.5	1.0034	1.0035	1.0035	1.0036	1.0036	1.0037
24	1.0035	1.0036	1.0036	1.0037	1.0038	1.0038
24.5	1.0037	1.0037	1.0038	1.0038	1.0039	1.0039
25	1.0038	1.0038	1.0039	1.0039	1.0040	1.0041
25.5	1.0039	1.0040	1.0040	1.0041	1.0041	1.0042
26	1.0040	1.0041	1.0042	1.0042	1.0043	1.0043
26.5	1.0042	1.0042	1.0043	1.0043	1.0044	1.0045
27	1.0043	1.0044	1.0044	1.0045	1.0045	1.0046
27.5	1.0044	1.0045	1.0046	1.0046	1.0047	1.0047
28	1.0046	1.0046	1.0047	1.0048	1.0048	1.0049
28.5	1.0047	1.0048	1.0048	1.0049	1.0050	1.0050
29	1.0049	1.0049	1.0050	1.0050	1.0051	1.0052
29.5	1.0050	1.0051	1.0051	1.0052	1.0052	1.0053
30	1.0052	1.0052	1.0053	1.0053	1.0054	1.0055





Appendix C - Evaporation Loss

Procedure for the Determination of Evaporation Loss

Use the same distilled water, weighing vessel, and balance as you will be using for the gravimetric check. Half fill the weighing vessel with distilled water.

1. Cover the weighing vessel with its lid and place it on the balance using a pair of tweezers.
2. Aspirate a sample.
3. Tare the balance and take the weighing vessel out of the balance.
4. Take off the lid with tweezers.
5. Dispense the sample into a dummy vessel.
6. Replace the lid on the weighing vessel and, using tweezers, replace the vessel on the balance.
7. Read the negative result e_1 (record the absolute value).
8. Repeat steps 3 to 8, three times to obtain e_2 , e_3 , and e_4 .
9. Calculate the evaporation loss e using the formula:

NOTE

In normal conditions, this value is usually between 0.01 mg and 0.03 mg. In normal conditions, this value is usually between 0.01 mg and 0.03 mg.

Appendix D - Glossary

Electronic and Hazard Symbols

DC  Direct Current (DC)

Safety Notices

WARNING

Indicates a potentially hazardous situation which, if not avoided, may result in serious injury.

CAUTION

Indicates a potentially hazardous situation which, if not avoided, may result in minor or moderate injury.

NOTICE

Indicates a potentially hazardous situation which, if not avoided, may result in equipment damage.

Gilson, Inc. • Manufacturer

3000 Parmenter Street | Middleton, WI 53562 | USA
T 608-836-1551 | T 800-445-7661 | F 608-831-4451

Gilson S.A.S • Manufacturer

19, avenue des Entrepreneurs | BP 145 | 95400 Villiers-le-Bel, France
T +33 (0) 1 34 29 50 00 | F +33 (0) 1 34 29 50 20

Specifications subject to change without notification — errors excepted.

gilson.com/contactus

LT801671/D | ©2026 Gilson, Inc. All rights reserved.

